



January 2020

High Definition Surveillance Products



Product Catalog

DIAMOND



www.nodactechnology.com

Product Catalog

Effective January 01, 2020

High Definition Surveillance Products



Technology developments that bring security

For information

CALL CENTER FREE
1-888-569-6062
in USA and Canada

www.nodactechnology.com

OCB reserves the right to modify, add or remove sale items. Prices & product specifications may change without prior notice. OCB is not responsible for typographical errors, images may be used for illustration purpose only and do not represent actual products. Dealer pricing only. tax not included. All prices effective January 01, 2018. OCB offers 3 Year limited warranty on Diamond products unless otherwise specified



Easy Configuration



A / Mini 1U Case



B/C/D/E / Compact 1U Case



No IP Configuration Hassle

No Extra VMS License Fee

Save on Bandwidth & Storage



Easy and Instant Remote Access

Linux Embedded System



Professional Level

	A	B	C	D	E
Model N°	OCB-8704MI-J1/4P	OCB-8708MI-R2/16P	OCB-NVR-8708MI-J2/8P	OCB-8716MI-R2/16P	OCB-8716MI-J2/16P
Video Input	4CH IP@40Mbps	8CH IP@80Mbps		16CH IP@160Mbps	
Record	2MP	4CH IP@30fps/CH		16CH IP@30fps/CH	
	4MP	4CH IP@20fps/CH	8CH@30fps/CH	16CH@20fps/CH	16CH@30fps/CH
	8MP	4CH IP@15Mfps/CH	8CH@20fps/CH	16CH@15fps/CH	16CH@20fps/CH
Video Output	HDMI up to 4K / VGA up to 1080P		HDMI up to 4K / VGA up to 1080P		HDMI up to 4K / VGA up to 1080P
Recording Resol.	Up to 4K, 8 MP (3840x2160)			Up to 4K, 8 MP (3840x2160)	
Decoding Format	H.265 / H.265+ / H.264 / H.264+				
Decoding Capability	1CH@4K / 4CH@1080P		2 CH@4K / 8CH@1080P	1CH@4K / 4CH@1080P	2CH@4K / 8CH@1080P
Playback Res.	Up to 4K, 8 MP (3840x2160)			Up to 4K, 8 MP (3840x2160)	
Audio In/Out	1 CH/ 1 CH, RCA				
Alarm In/Out			4/1		4/1
Built-in PoE	4CH	8CH		16CH	
Network	10/100/100M, RJ45				
Storage	1 SATA up to 6TB, NAS, IP SAN	2 SATA up to 12TB, NAS, IP SAN		2 SATA up to 12TB, NAS, IP SAN	
Dimensions	12.4"(W) x9.1"(D) x1.8"(H)	15"(W)x12.4"(D)x1.8"(H)			
Backup	2 USB 2.0		1 USB 2.0, 1 USB 3.0	2 USB 2.0	1 USB 2.0, 1 USB 3.0

4K
H.265+

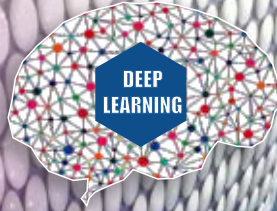

Extended PoE

Unleash The Distance Limit

A/B
Compact 1U Case



Extend the PoE Up to 800 ft



Enterprise Level

		A	B
Model N°		OCB-NVR-N5208-I2/P8	OCB-NVR-N5216-I2/P16
Video Input		8CH IP@40Mbps	16CH IP@160Mbps
Record	2MP	8CH IP@30fps/CH	16CH IP@30fps/CH
	4MP	8CH IP@30fps/CH	16CH IP@30fps/CH
	8MP	8CH IP@20fps/CH	16CH IP@20fps/CH
Video Output		HDMI up to 4K(3840x2160),VGA up to 1920x1080P, CVBS up to 704x480	
Recording Resol.		Up to 12 MegaPixels (4000x3072)	
Decoding Format		H.265 / H.265+ / H.264 / H.264+	
Decoding Capability		3CH@4K / 12CH@1080P	
Playback Res.		Up to 12 MegaPixels (4000x3072)	
Deep Learning Support		4CH Human/Vehicle Detection	
Audio In/Out		1CH/1CH, RCA	
Alarm In/Out		4/1	
Built-in PoE		8CH	16CH
Network		10/100/1000M, 1 RJ45	
Storage		2 SATA up to 16TB, NAS, IP SAN	
Support Fisheye Cameras		6	
Support POS		4 (TCP)	8 (TCP)
Dimensions		15"(W)x12.4"(D)x1.8"(H)	
Backup		1 USB 2.0, 1 USB 3.0	

4K
H.265+

Extended PoE

Unleash The Distance Limit

C/D/E/F/G/H
1U Case



Standard PoE 330 ft



Enterprise Level

	B	C	D	F	G	H
Model N°	OCB-NVR-N5216-I2	OCB-NVR-N5316-I4/P16	OCB-8832MI-J4	OCB-NVR-N5332-I4	OCB-NVR-N5332-I4/P16	
Video Input	16CH IP@160Mbps		32CH IP@250Mbps			
Record	2MP	16CH IP@30fps/CH		32CH IP@30fps/CH		
	4MP	16CH IP@30fps/CH		32CH IP@30fps/CH		
	8MP	16CH IP@20fps/CH		32CH IP@20fps/CH		
Video Output	HDMI1 up to 4K(3840x2160), HDMI2/VGA up to 1920x1080P, CVBS up to 704x480		HDMI 4K, VGA 1080P, CVBS 704x480	HDMI1 up to 4K(3840x2160), HDMI2/VGA up to 1920x1080P, CVBS up to 704x480		
Recording Resol.	Up to 12 MegaPixels (4000x3072)					
Decoding Format	H.265 / H.265+ / H.264 / H.264+					
Decoding Capability	4CH@4K / 16CH@1080P					
Playback Res.	Up to 12 MegaPixels (4000x3072)					
Audio In/Out	1CH/1CH, RCA					
Alarm In/Out	16/4					
Built-in PoE		16CH			16CH	24CH
Network		10/100/1000M, 2 RJ45	10/100/1000M, 1 RJ45	10/100/1000M, 2 RJ45		10/100/1000M, 1 RJ45
Storage	2 SATA up to 16TB, NAS, IP SAN	4 SATA up to 32TB, eSATA, NAS, IP SAN				
Support Fisheye Cameras	6		8			
Support POS	8 (TCP or RS232)		16 (TCP or RS232)			
Dimensions	17.5"(W)x15.3"(D)x2.8"(H)					
Backup	2 USB 2.0, 1 USB 3.0, eSATA, DVD-RW					

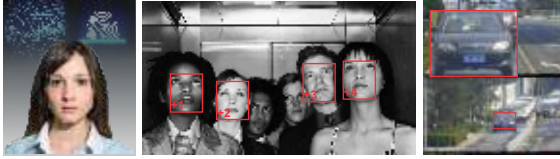

Human & Vehicle Detection

- Accurate detection of human and vehicle, over 1000 times more accurate than regular motion detection
- Filter out false alarm, save hours on searching playback footage

J/ 1.5 U Case **4K** H.265+ **AI**



K/L / 2 U Case **4K** H.265+ **RAID**



M/N / 3 U Case **4K** H.265+ **RAID**



Enterprise Level

	J	K	L	M	N	
Model N°	OCB-8832MYI-J4/16P	OCB-10732MYI-J8	OCB-10764MYI-J8	OCB-107128MYI-J16	OCB-107256MYI-J16	
Video Input	32CH IP@256Mbps	32CH IP@320Mbps	64CH IP@320Mbps	128CH IP@768Mbps	256CH IP@768Mbps	
Record	2MP	32CH IP@30fps/CH	32CH IP@30fps/CH	64CH IP@30fps/CH	128CH IP@30fps/CH	256CH IP@15fps/CH
	4MP	32CH IP@30fps/CH	32CH IP@30fps/CH	64CH IP@20fps/CH	128CH IP@20fps/CH	256CH IP@10fps/CH
	8MP	32CH IP@20fps/CH	32CH IP@20fps/CH	64CH IP@15fps/CH	128CH IP@12fps/CH	256CH IP@6fps/CH
Video Output	HDMI1 up to 4K(3840x2160), HDMI2/VGA up to 1920x1080P, CVBS up to 704x480	HDMI1 up to 4K(3840x2160)/VGA1 up to 2K(2560x1440), HDMI2/VGA2 up to 1920x1080P		HDMI1 4K / VGA 1080P, HDMI2 up to 4K (4096x2160)	HDMI1 4K / VGA 1080P, HDMI2 up to 4K, Built-in 7" Touch Screen LCD, 6 HDMI TV Wall	
Recording Resol.	Up to 12 MegaPixels (4000x3072)					
Decoding Format	H.265 / H.265+ / H.264 / H.264+					
Decoding Capability	3CH@4K / 12CH@1080P	4CH@4K / 16CH@1080P		5CH@4K / 20CH@1080P		
Playback Res.	Up to 12 MegaPixels (4000x3072)					
Deep Learning Support	4CH Human/Vehicle Detection					
Audio In/Out	1CH/1CH, RCA	1CH/2CH, RCA		1CH/1CH, RCA		
Alarm In/Out	16/4			48/24		
Built-in PoE	16CH					
Network	10/100/1000M, 1 RJ45		10/100/1000M, 2 RJ45		10/100/1000M, 4 RJ45, 4 Fiber Optic	
Storage	4 SATA up to 32TB, eSATA, NAS, IP SAN		8 SATA up to 80TB, eSATA, NAS, IP SAN RAID 0, 1, 5, 6, and 10, Hot Swap		16 SATA up to 160TB, NAS, IP SAN RAID 0, 1, 5, 6 and 10, Hot Swap	
Support Fisheye Cameras	8			16		
Support POS	16 (TCP or RS232)			16 (TCP)		
Dimensions	17.5"(W)x15.3"(D)x2.8"(H)		17.5"(W)x18.5"(D)x3.5"(H)		17.5" (W)×19.4"(D)× 5.7"(H)	
Backup	2 USB 2.0, 1 USB 3.0, eSATA			2 USB 2.0, 2 USB 3.0		

OCB
electronics

ONVIF

UL US
Listed

NODAC
TECHNOLOGY

A/ Mini 1U Case

H.265+
HYBRID



D

B/C / 1U Case

4K H.265+
HYBRID



Hybrid Solutions

	A	B	C	D
Model N°	OCB-8204JUJI-L1	OCB-8208JUJI-L2	OCB-8216JUJI-L2	OCB-NVR-H5208-WF
Analog Video Input	4CH up to 5MP HD-TVI4.0/AHD/CVI /960H Self-adaptive	8CH up to 4K/8MP HD-TVI4.0/AHD/CVI/ 960H Self-adaptive	16CH up to 4K/8MP HD-TVI4.0/AHD/CVI/ 960H Self-adaptive	
IPC Input	4CH up to 4K/8MP (3840x2160)	8CH up to 4K/8MP (3840x2160)	16CH up to 4K/8MP (3840x2160)	4CH up to 4 MegaPixels (2048x1536)
Bandwidth	96Mbps	128Mbps		50Mbps
Video Output	VGA/HDMI up to 1920x1080P, CVBS	HDMI output up to 4K (3840x2160P) / VGA up to 1920x1080P, CVBS		HDMI up to 1920x1080P
Recording Resol.	Up to 4K, 8 MegaPixels (3840x2160)			Up to 4 MegaPixels (2048x1536)
Decoding Format	H.265 / H.265+ / H.264 / H.264+			H.264
Playback Res.	Up to 4K, 8 MegaPixels (3840x2160)			Up to 4 MegaPixels (2048x1536)
Audio In/Out	4CH/1CH, RCA			
Alarm In/Out	4CH/1CH	8CH/4CH	16CH/4CH	4CH/1CH
Network	10/100/1000M, 1 RJ45			1x 10/100M WAN, 3x 10/100M LAN Wifi 802.11n 300Mbps, 2x2 MIMO
Storage	1 SATA up to 8TB, NAS, IP SAN	2 SATA up to 16TB, NAS, IP SAN		1TB 2.5"HDD (Included), NAS, IP SAN
Support POS			4 (TCP)	
Dimensions	12.4"(W)x9.1"(D)x1.8"(H)	15"(W)x12.4"(D)x1.8"(H)		3.4 "(W)×3.4"(D) ×6.2"(H)
Backup	2 USB 2.0	1 USB 2.0, 1 USB 3.0		1 USB 3.0

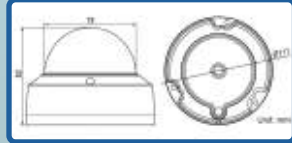

KEY FEATURES

- ◆ Micro SD/SDHC/SDXC Card Slot up to 128GB
- ◆ ANR (Automatic Network Replenishment)
- ◆ 3-Axis
- ◆ IP67, IK10 Vandal-Proof
- ◆ 3D DNR, BLC
- ◆ DC 12V, PoE
- ◆ UL Listed
- ◆ 3 Year Warranty

OCB-3DE3222H0-I
<p>2MP 12 IR up to 70ft, 2.8mm Fixed Lens 1920 x 1080@30fps, H.264 DWDR, Special Design for Wide FoV</p>

OCB-3DE3221J0-IW
<p>2MP 12 IR up to 70ft 2.8mm Fixed Lens 1920 x 1080@30fps, H.264 DWDR, Special Design for Wide FoV, Built-in Wi-Fi</p> 

OCB-3DE3421J0-IW
<p>4MP 30 IR up to 100ft 2.8mm Fixed Lens 2688 x 1520@20fps, H.264/H.264+ True WDR 120dB, Built-in Wi-Fi</p>  

KEY FEATURES

- ◆ Advanced Compression H.265/H.265+
- ◆ Matrix IR LED up to 100ft
- ◆ Motorized Lens with Smart Focus
- ◆ Micro SD/SDHC/SDXC Card Slot up to 128GB
- ◆ True WDR 120dB
- ◆ 3.5mm Audio Jack I/O, Alarm I/O
- ◆ Video Content Analytics
- ◆ ANR (Automatic Network Replenishment)
- ◆ IP67, IK10 Vandal Proof
- ◆ 3D DNR, BLC, DC 12V, PoE

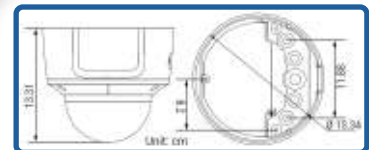



OCB- 3DE2863H0-IZ
<p>6MP 2.8 - 12 mm VF Motorized Lens 3072 x 2048@20fps 0.018 Lux @ F1.6i</p>



OCB- 3DE2843H0-IZ
<p>4MP 2.8 - 12 mm VF Motorized Lens 2688 x 1520@30fps 0.018 Lux @ F1.6</p>

OCB-3DE3885FWS-IZS
<p>8MP/4K 2.8 - 12 mm VF Motorized Lens, 3840 x 2160@15fps 0.018 Lux @ F1.6</p> 

OCB-1273ZJ-135 OCB-1271ZJ-135

	
Wall Mount	Pendant Mount

OCB-B275ZPM OCB-B276ZCM



	
Vertical Pole Mount	Corner Mount



KEY FEATURES

- ◆ Advanced Compression H.265/H.265+
- ◆ Matrix IR LED up to 100ft
- ◆ Micro SD/SDHC/SDXC Card Slot up to 128GB
- ◆ True WDR 120dB
- ◆ Video Content Analytics
- ◆ ANR (Automatic Network Replenishment)
- ◆ 3 Axis
- ◆ IP67, IK10 Vandal Proof
- ◆ 3D DNR, BLC
- ◆ DC 12V, PoE
- ◆ UL Listed
- ◆ 3 Years Warranty



<p>OCB-3DE3143J0-I OCB-3DE3143J0-IB</p> <p>4MP 2.8mm Fixed Lens 2688 × 1520@30fps 0.018 Lux @ F1.6 White or Black Housing</p>	<p>OCB-3DE3143J0-I-4M</p> <p>4MP 4mm Fixed Lens 2688 × 1520@30fps 0.018 Lux @ F1.6</p>	<p>OCB-3DE3143J0-I-6M</p> <p>4MP 6mm Fixed Lens 2688 × 1520@30fps 0.018 Lux @ F1.6</p>	<p>OCB-3DE3263J0-I OCB-3DE3263J0-IB</p> <p>4MP 6mm Fixed Lens 2688 × 1520@30fps 0.018 Lux @ F1.6</p>
<p>OCB-3DE3263J0-I-4M</p> <p>6MP 4mm Fixed Lens 3072 × 2048@20fps</p>	<p>OCB-3DE3263J0-I-6M</p> <p>6MP 6mm Fixed Lens 3072 × 2048@20fps</p>	<p>OCB-3DE3285FWD-IS</p> <p>8MP/4K </p> <p>2.8mm Fixed Lens 3840 × 2160@15fps</p>	<p>OCB-3DE3285FWD-IS-4M</p> <p>8MP/4K </p> <p>4mm Fixed Lens 3840 × 2160@15fps</p>

<p>OCB-1280ZJ-DM18</p>  <p>Junction Box</p>	<p>OCB-1259ZJ</p>  <p>Angled Base (150)</p>	<p>OCB-1258ZJ</p>  <p>Wall Mount</p>
---	---	--

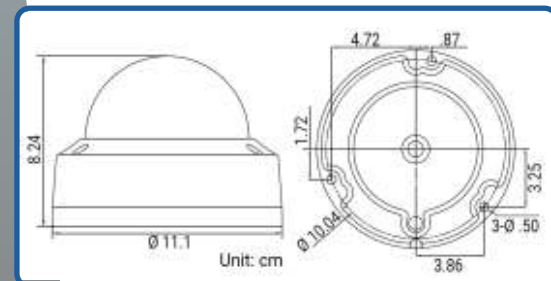

<p>OCB-1272ZJ-110</p>  <p>Wall Mount</p>	<p>OCB-1272ZJ-110B</p>  <p>Wall Mount</p>	<p>OCB-1271ZJ-135</p>  <p>Pendant Mount</p>	<p>OCB-B275ZPM</p>  <p>Pole Mount</p>	<p>OCB-B276ZCM</p>  <p>Corner Mount</p>
--	---	---	---	---



Video Door Bell



Security at your Door

Conectivity,
Speed,
Ease,
Security at your reach...



OCB-KB6003-WIP

- ◆ 2MP Full HD
- ◆ 80° Panoramic View
- ◆ 1920 x 1080
- ◆ IR up to 15ft
- ◆ Two-way Audio
- ◆ 16VAC - 24VAC
- ◆ Built-in Wi-Fi
- ◆ DWDR, 3D DNR
- ◆ MicroSD Card Slot Up to 128GB



IP Dome Cameras

KEY FEATURES

- ◆ Advanced Compression H.265/H.265+
- ◆ Matrix IR LED up to 33ft
- ◆ Micro SD/SDHC/SDXC Card Slot up to 128GB
- ◆ Built-in Microphone
- ◆ True WDR 120dB
- ◆ Video Content Analytics
- ◆ ANR (Automatic Network Replenishment)
- ◆ 3 Axis
- ◆ IP66, IK8 Vandal Proof
- ◆ 3D DNR, BLC
- ◆ DC 12V, PoE
- ◆ UL Listed



OCB-3DE3623H0-I

4MP
2.8mm Fixed Lens
2688 x 1520@30fps
0.018 Lux @ F1.6

OCB-3DE3643H0-IWS

4MP
2.8mm Fixed Lens
2688 x 1520P@30fps
0.018 Lux @ F1.6
Built-in Wi-Fi



OCB-3DE3663H0-IS

6MP
2.8mm Fixed Lens
3072 x 2048@20fps

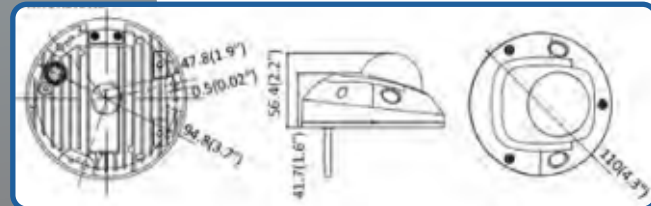

KEY FEATURES

- B-H**
- ◆ Advanced Compression H.265/H.265+
 - ◆ Matrix IR LED up to 100ft
 - ◆ Micro SD/SDHC/SDXC Card Slot up to 128GB
 - ◆ True WDR 120dB
 - ◆ Video Content Analytics
 - ◆ ANR (Automatic Network Replenishment)
 - ◆ IP67
 - ◆ 3D DNR, BLC
 - ◆ DC 12V, PoE
 - ◆ UL Listed

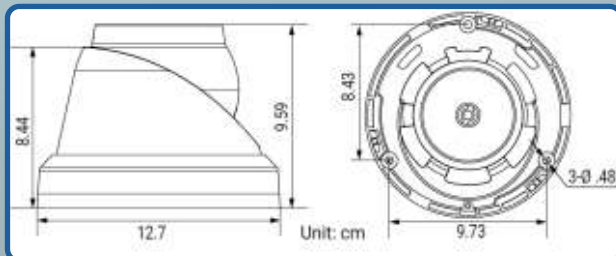

A OCB-3DE3421J0-I

2MP

2.8mm Fixed Lens
1920 × 1080@30fps
H.264
DWDR

B OCB-3DE3443J0-I OCB-3DE3421J0-I-4mm

2MP

2.8mm/4mm Fixed Lens
1920 × 1080@30fps

C OCB-3DE3443J0-IB OCB-3DE3443J0-I-4mm

4MP

2.8mm Fixed Lens
2688 × 1520@30fps
0.018 Lux @ F1.6
White or Black Housing

D OCB-3DE3463H0-I OCB-3DE3443J0-I-6mm

4MP

4mm/6mm Fixed Lens
2688 × 1520@30fps
0.018 Lux @ F1.6

E OCB-3DE3463H0-I OCB-3DE3463H0-IB

6MP

2.8mm Fixed Lens
3072 × 2048@20fps
White or Black Housing

F OCB-3DE3463H0-I-4MM OCB-3DE3463H0-I-6mm

6MP

4mm/6mm Fixed Lens
3072 × 2048@20fps

G OCB-3DE3483J0-I

8MP/4K



2.8mm Fixed Lens
3840 × 2160@15fps

H OCB-3DE3483J0-I-4M

8MP/4K



4mm Fixed Lens
3840 × 2160@15fps

OCB D9020 JB	OCB-1280ZJ-M	OCB-1273ZJ-130-TRL	OCB-1271ZJ-135	OCB-B275ZPM	OCB-B276ZCM
Junction Box	Junction Box	Wall Mount	Pendant Mount	Pole Mount	Corner Mount

KEY FEATURES

- ◆ Advanced Compression H.265/H.265+
- ◆ Matrix IR LED up to 100ft
- ◆ Motorized Lens with Smart Focus
- ◆ Micro SD/SDHC/SDXC Card Slot up to 128GB
- ◆ True WDR 120dB
- ◆ 3.5mm Audio Jack I/O, Alarm I/O
- ◆ Video Content Analytics
- ◆ ANR (Automatic Network Replenishment)
- ◆ IP67, IK10 Vandal Proof
- ◆ 3D DNR, BLC
- ◆ DC 12V, PoE
- ◆ UL Listed
- ◆ Junction Box included

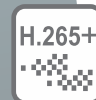
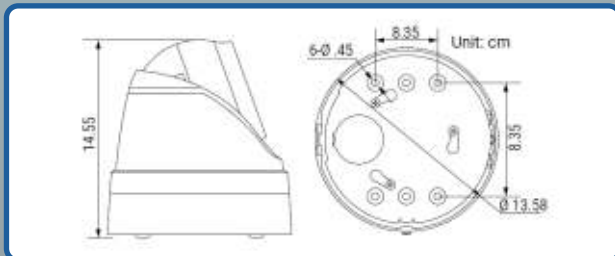

OCB-3DE3I63H21-IZ

6MP

2.8 - 12 mm VF Motorized Lens
3072 × 2048@20fps
0.018 Lux @ F1.4

OCB-3DE3I63H21D-IZ

6MP

2.8 - 12 mm VF Motorized Lens
3072 × 2048@20fps
0.014 Lux @ F1.6

OCB-2CD2H85FWD-IZS

8MP/4K



2.8 - 12 mm VF Motorized Lens
3840 × 2160@15fps
0.018 Lux @ F1.6

OCB-1273ZJ-135-TRL



Wall Mount

OCB-1271ZJ-135



Pendant Mount

OCB-B275ZPM



Vertical Pole Mount

OCB-B276ZCM



Corner Mount



B / C / D / E / F



KEY FEATURES

- B - F**
- Advanced Compression H.265/H.265+
 - Matrix IR LED up to 100ft
 - Micro SD/SDHC/SDXC Card Slot up to 128GB
 - True WDR 120dB
 - ANR (Automatic Network Replenishment)
 - Video Content Analytics
 - IP67
 - 3D DNR, BLC
 - DC 12V, PoE
 - UL Listed

A OCB-IPC-HW-CI3020

2MP
4mm Fixed Lens
1920 x 1080@30fps
H.264
DWDR
Built-in Wi-Fi



B OCB-IPC-HW-CI3020-IW-4mM

2MP
4mm Fixed Lens
1920 x 1080@30fps

C OCB-IPC-HW-CI3040 OCB-IPC-HW-CI3040B

4MP
2.8mm Fixed Lens
2688 x 1520@30fps
0.018 Lux @ F1.6
White or Black Housing

D OCB-IPC-HW-CI3040-4MM

4MP
4mm Fixed Lens
2688 x 1520@30fps
0.018 Lux @F1.6

E OCB-IPC-HW-CI3060

6MP
2.8mm Fixed Lens
3072 x 2048@20fps

F OCB-IPC-HW-CI3060-4MM

6MP
4mm Fixed Lens
3072 x 2048@20fps

OCB-1280ZJ-XS



Universal Junction Box

OCB-1280ZJ-XSB



Universal Junction Box (Black)

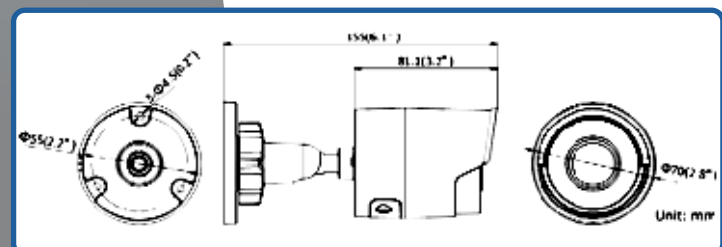

KEY FEATURES

- Advanced Compression H.265/H.265+
- Matrix IR LED up to 165ft
- Micro SD/SDHC/SDXC Card Slot up to 128GB
- True WDR 120dB, IP67
- Video Content Analytics
- ANR (Automatic Network Replenishment)
- 3D DNR, BLC, DC 12V, PoE
- UL Listed



OCB- 3DE3U43H0-I5	OCB- 3DE3U43H0-I5-4MM
4MP 2.8mm Fixed Lens 2688 × 1520@30fps 0.018 Lux @ F1.6	4MP 4mm Fixed Lens 2688 × 1520@30fps 0.018 Lux @ F1.6

OCB- 3DE3U43H0-I5-6MM	OCB- 3DE3U63H0-I5
4MP 6mm Fixed Lens 2688 × 1520@30fps 0.018 Lux @ F1.6	6MP 2.8mm Fixed Lens 3072 × 2048@20fps

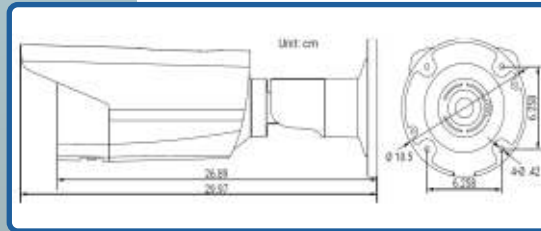

OCB-B275ZPM
Pole Mount
OCB-B276ZCM
Corner Mount

OCB- 3DE3U63H0-I5-4MM	OCB- 3DE3U63H0-I5-6MM	OCB- 3DE3U83H0-I5	OCB- 3DE3U83H0-I5-4MM
6MP 4mm Fixed Lens 3072 × 2048@20fps	6MP 6mm Fixed Lens 3072 × 2048@20fps	8MP/4K 2.8mm Fixed Lens 3840 × 2160@15fps	8MP/4K 4mm Fixed Lens 3840 × 2160@15fps

IP Bullet Cameras

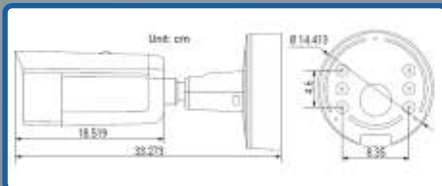

KEY FEATURES

- Advanced Compression H.265/H.265+
- Matrix IR LED up to 165ft
- Motorized Lens with Smart Focus
- Micro SD/SDHC/SDXC Card Slot up to 128GB
- True WDR 120dB
- 3.5mm Audio Jack I/O, Alarm I/O
- Video Content Analytics
- ANR (Automatic Network Replenishment)
- IP67, IK10 Vandal Proof
- 3D DNR, BLC, DC 12V, PoE
- UL Listed

OCB-3DE3745FWD-IZS	OCB-3DE3765FWD-IZS	OCB-3DE3785FWD-IZS
4MP 2.8 - 12 mm VF Motorized Lens 2688 × 1520@30fps 0.018 Lux @ F1.6	6MP 2.8 - 12 mm VF Motorized Lens 3072 × 2048@20fps 0.018 Lux @ F1.6	8MP/4K 2.8 - 12 mm VF Motorized Lens 3840 × 2160@15fps 0.018 Lux @ F1.6

OCB-B275ZPM
Pole Mount
OCB-B276ZCM
Corner Mount

◆ LPR IP Bullet Camera



S MB 5006



A) OCB-3DE8BA20H0/P

2MP

8 - 20 mm VF
Motorized Lens
1920 × 1080@30fps
White Flux LED
0.014 Lux @ F1.4
MicroSD Card Slot
up to 128GB
Audio I/O, Alarm I/O
IP67

B) OCB-3DE8BA26H0/P-IZS

2MP

8 - 32 mm Auto Focus VF
Motorized Lens
1920 × 1080@60fps
Matrix IR up to 328ft
0.0027 Lux @ F1.4
Up to 60MPH
License Plate Recognition
Searchable from IP
Camera or NVR
MicroSD Card Slot
up to 128GB
Audio I/O, Alarm I/O
IP67



◆ IP Turret Camera

OCB-3DE2423J0-I

2MP

2.8mm Fixed Lens
1920 x 1080@30fps

OCB-3DE2443J0-I

4MP

2.8mm Fixed Lens
2560 x 1440@20fps

OCB-1273ZJ-130-TRL



Wall Mount

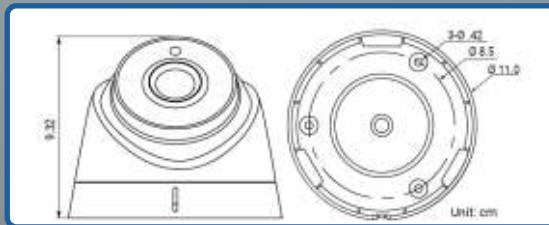

OCB D9020 JB



Junction Box

OCB-1280ZJ-M



Junction Box

OCB-B276ZCM



Corner Mount

OCB-B275ZPM



Pole Mount



KEY FEATURES

- ◆ Advanced Compression
H.265/H.265+
- ◆ Matrix IR LED up to 100ft
- ◆ IP67
- ◆ DWDR, 3D DNR, BLC
- ◆ DC 12V, PoE
- ◆ UL Listed
- ◆ Metal Housing



OCB-IPC-1143G0-I

4MP
2.8mm Fixed Lens
2560 x 1440@20fps

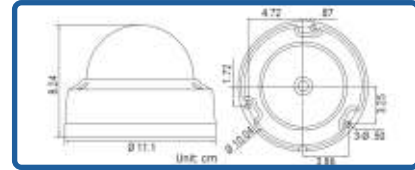

KEY FEATURES

- ◆ Advanced Compression H.265/H.265+
- ◆ IR LED up to 70ft
- ◆ IP67, IK10 Vandal-Proof
- ◆ DWDR, 3D DNR, BLC
- ◆ 2-Axis
- ◆ DC 12V, PoE
- ◆ UL Listed
- ◆ Metal Housing

OCB-1280ZJ-DM18  Junction Box	OCB-1259ZJ  Angled Base (15°)	OCB-1258ZJ  Wall Mount	OCB-1272ZJ-110  Wall Mount
OCB-1272ZJ-110B  Wall Mount	OCB-1271ZJ-110  Pendant Mount	OCB-B275ZPM  Pole Mount	OCB-B276ZCM  Corner Mount

IP Bullet Camera

KEY FEATURES

- ◆ Advanced Compression H.265/H.265+
- ◆ Matrix IR LED up to 100ft
- ◆ IP67
- ◆ DWDR, 3D DNR, BLC
- ◆ DC 12V, PoE
- ◆ UL Listed
- ◆ Metal Housing



OCB-3DE2123H0-I

2MP
2.8mm Fixed Lens
1920 x 1080@30fps

OCB-3DE2143H0-I
OCB-3DE2143H0-I-4MM

4MP
2.8mm/4mm Fixed Lens
2560 x 1440@20fps

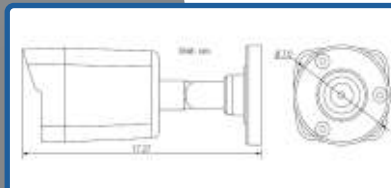

OCB-1280ZJ-XS



Universal Junction Box

Multi-Lens Camera



1 x multi-lens camera = 360° view
4 x 2MP cameras
1 time installation



Easier Installation x 4



KEY FEATURES

- 4 Physical Cameras in 1 Housing
- Non Stichable
- 60W PoE Injector Included
- Save Labor with Multi Lens by Using 1 Ethernet Cable
- 4 Adjustable Viewing Angle Cameras with Motorized Lens
- 8 Matrix IR up to 100ft

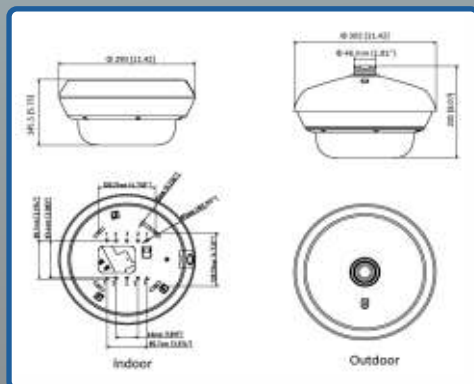

OCB-3DE7E24FWD-IZS

4 x 2MP Flexible Lens (8MP)
2.8 - 12mm Auto Focus Motorized Lens
1920 x 1080@30fps
Advanced Compression H.265/H.265+
True WDR 120dB
MicroSD Card Slot up to 128GB
Audio I/O, Alarm I/O
IP67, IK10

OCB-3DE7E54FWD-IZS

4 x 5MP Flexible Lens (20MP)
2.8 - 12mm Auto Focus Motorized Lens
2560 x 1920@30fps
Advanced Compression H.265/H.265+
True WDR 120dB
MicroSD Card Slot up to 128GB
Audio I/O, Alarm I/O
IP67, IK10

OCB-1602ZJ-E	OCB-1661ZJ-20	OCB-1661ZJ	OCB-1660ZJ	OCB-B276ZCM	OCB-B275ZPM
Wall Mount	Pendant Mount 7.8" (20cm)	Pendant Mount 20" (50cm)	Parapet Wall Mount	Pole Mount	Corner Mount

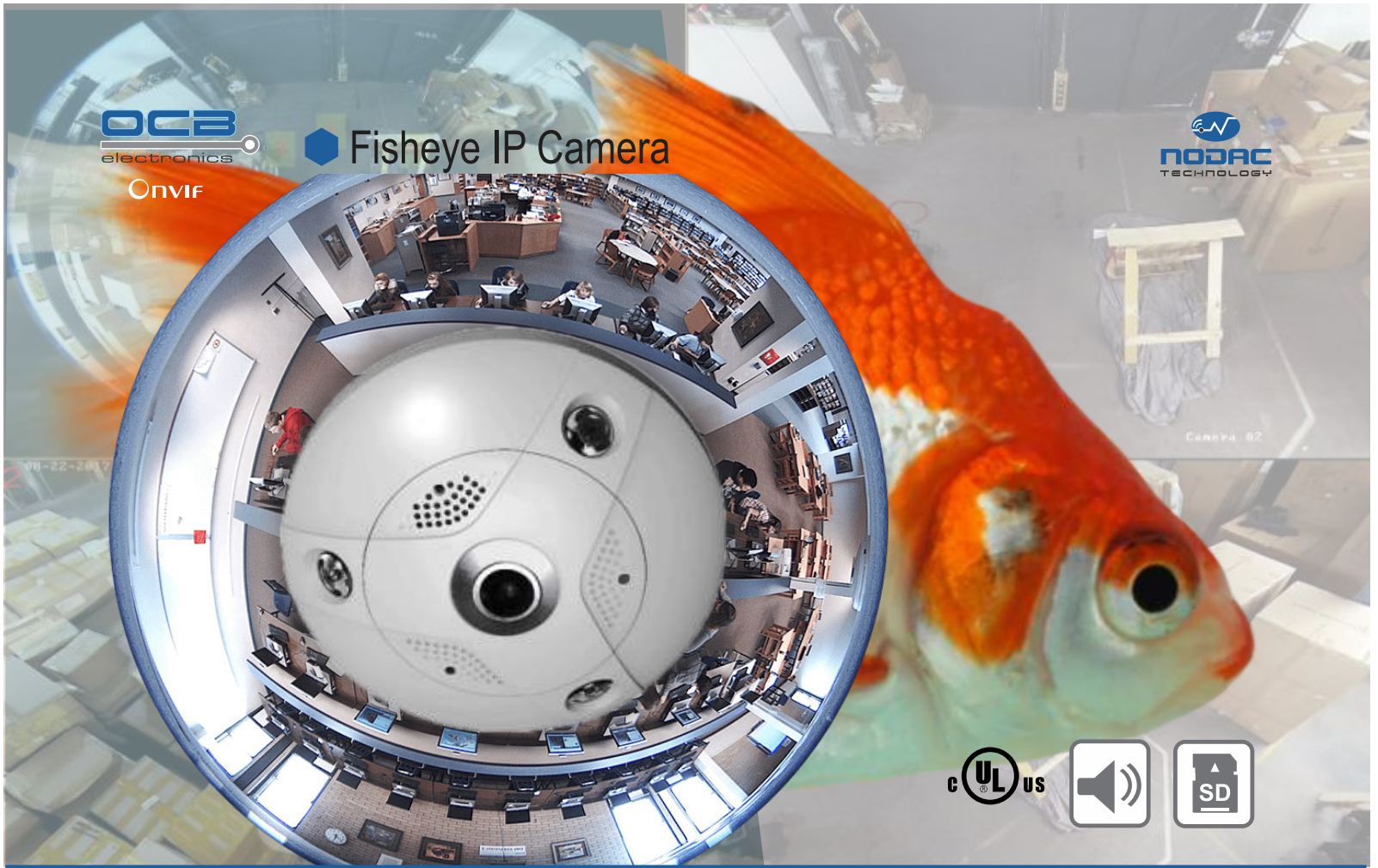

KEY FEATURES

- ◆ 360° Fisheye and 180° Panoramic View
- ◆ Multiple Viewing Modes and Virtual PTZ
- ◆ Support H.264/H.264Zip+
- ◆ Micro SD/SDHC/SDXC Card Slot up to 128GB
- ◆ Video Content Analytics
- ◆ Heat Map for Motion Analytics
- ◆ Low-light, IR up to 33ft
- ◆ IP66, IK10 Vandal-Proof
- ◆ Built-in Microphone, Audio I/O
- ◆ DWDR
- ◆ DC12V, PoE
- ◆ UL Listed

OCB-3DE7462F-IVS

Fisheye IP Camera **6MP**
1.27mm Fixed Lens
3072 x 2048@25fps
Outdoor/Indoor

OCB-3DE74D3E-IVS

Fisheye IP Camera **12MP**
1.98mm Fixed Lens
4000 x 3072@25fps
Audio I/O, Alarm I/O
Outdoor/Indoor

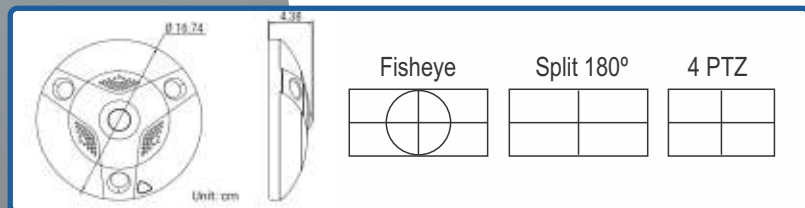

OCB-1283ZJ



Wall Mount

OCB-1271ZJDM25



Ceiling Mount

OCB-1280ZJDM25

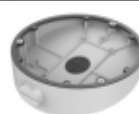

Inclined Ceiling/Wall Mount

OCB-B275ZPM



Corner Mount

OCB-B276ZCM

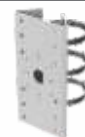

Pole Mount



Color 24/7 IP Camera

COLOR 24/7 IP

Color247 cameras record forensic evidence in color and produce sharper and clearer images compared to traditional IR.



Without Color

With Color



A	OCB-3DE3447H3E
4MP Color247 IP Camera Advanced Compression H.265/H.265+ 0.0014 Lux @ F1.0 Ultra Low Lux 4mm Fixed Lens, 2560 x 1440@24fps True WDR 120dB, IP67 MicroSD Card Slot up to 128GB	

B	OCB-3DE3U47H3E
4MP Color247 IP Camera Advanced Compression H.265/H.265+ 0.0014 Lux @ F1.0 Ultra Low Lux 4mm Fixed Lens, 2560 x 1440@24fps True WDR 120dB, IP67 MicroSD Card Slot up to 128GB	

AI/Deep Learning IP Camera



C



D



E

C	OCB-3DE3446H1-I	D	OCB-3DE3246H1-IS	E	OCB-3DE3U46HI-2I
4MP Ultra Darksight IP Camera AI Smart IP Camera with Human and Vehicle Detection Advanced Compression H.265/H.265+ 0.012 Lux @ F1.6 Matrix IR up to 164ft, 2.8mm Fixed Lens 2688 x 1520@30fps True WDR 120dB, IP67 MicroSD Card Slot up to 128GB		4MP Ultra Darksight IP Camera AI Smart IP Camera with Human and Vehicle Detection Advanced Compression H.265/H.265+ 0.012 Lux @ F1.6 Matrix IR up to 98ft, 2.8mm Fixed Lens 2688 x 1520@30fps True WDR 120dB, IP67, IK10 MicroSD Card Slot up to 128GB		4MP Ultra Darksight IP Camera AI Smart IP Camera with Human and Vehicle Detection Advanced Compression H.265/H.265+ 0.012 Lux @ F1.6, Matrix IR up to 164ft 2.8mm Fixed Lens, 2688 x 1520@30fps True WDR 120dB MicroSD Card Slot up to 128GB IP67	

OCB-3DE3241H1-IDW1	OCB-3DE3141H1-IDW1	OCB-3DE3543H0-IW
 <div data-bbox="251 682 651 766">      </div>	 <div data-bbox="706 682 1106 766">      </div>	 <div data-bbox="1161 682 1561 766">      </div>
<p>4MP 2560 x 1440@20fps 2.8mm Fixed Lens H.265/H.265+ Matrix IR up to 100ft MicroSD Card Slot up to 128GB Built-in Microphone, Alarm I/O True WDR 120dB IP66 Built-in Wi-Fi up to 450ft 2 Axis</p>	<p>4MP 2560 x 1440@20fps 2.8mm Fixed Lens H.265/H.265+ Matrix IR up to 100ft MicroSD Card Slot up to 128GB Built-in Microphone, Alarm I/O True WDR 120dB IP66 Built-in Wi-Fi up to 450ft 2 Axis</p>	<p>4MP 2560 x 1440@20fps 2.8mm Fixed Lens H.265/H.265+ Matrix IR up to 100ft MicroSD Card Slot up to 128GB Built-in Microphone, Alarm I/O True WDR 120dB IP66 Built-in Wi-Fi up to 450ft 2 Axis</p>



OCB-3DE4794HI-IZ	OCB-3DEF5H28	OCB-3DE7412FWD
 <div data-bbox="278 1719 669 1803">     </div>	 <div data-bbox="1042 1719 1121 1803">  </div>	 <div data-bbox="1406 1719 1570 1803">   </div>
<p>2MP Long Range IP Bullet Camera 4.7 - 94mm Auto Focus VF Motorized Lens 1920 x 1080 up to 60fps 0.007 Lux @ F1.4 Ultra Low Light Matrix IR up to 394ft, True WDR 120dB HLC, 3D DNR, BLC, DC12V, PoE</p>	<p>2MP Magnetic Dome Cover IP Camera In-Ceiling IP Camera Snap-On Magnetic No Screw Dome Cover 4mm Fixed Lens, 1920 x 1080@30fps H.264, DC12V, PoE DWDR, 3D DNR, BLC</p>	<p>1.3MP People Counting IP Camera 2.8mm Fixed Lens 1280 x 960@30fps Support H.264/H.264Zip+ MicroSD Card Slot up to 128GB True WDR 120dB, Audio I/O, Alarm I/O Length of Cable: 6ft, DC12V</p>

OCB2104IP 2MP	OCB 2102IP 2MP	OCB-IPC-HB9301E
  	  	   
<p>2MP Pinhole IP Camera 2.8mm Fixed Lens, 1920 x 1080@30fps Advanced Compression H.265/H.265+ True WDR 120dB, Audio Input Video Content Analytics, DC12V</p>	<p>2MP Pinhole IP Camera 3.7mm Fixed Lens, 1920 x 1080@30fps Advanced Compression H.265/H.265+ True WDR 120dB, Audio Input Video Content Analytics, DC12V</p>	<p>3MP Box IP Camera 2048 x 1536@20fps Support H.264/H.264Zip+ MicroSD Card Slot up to 128GB True WDR 120dB, Audio I/O, Alarm I/O DC12V/AC24V/PoE, Auto Iris *Lens Sold separately*</p>

EVD-550V	EVD-05100A	EVD02812AMIR
		
<p>2MP HD Lens, F1.4 Varifocal 5 - 50mm 1/3", Auto Iris, CS Mount</p>	<p>2MP Long Range Lens, F1.6 Varifocal 5 - 100mm 1/3", Auto Iris, CS Mount</p>	<p>3MP HD Lens, F1.4 Varifocal 2.8 - 12mm 1/2.7", Auto Iris, CS Mount</p>



Don't see what you Need? 

Go on-line for our complete product offering.
www.nodactechnology.com

Or just call us for any information

Call Center FREE
1-888-569-6062

Detects Moving Targets
Tracks Movement
Zoom in for Forensic Details

OCB-3DF5B425IW-DE



OCB-3EF3B204IW

2.1MP, Full HD 1080P, 1/3" CMOS
0.005Lux@F1.6 Ultra Low Light
1920x1080P@30fps
2.8 - 12mm
4x Optical Zoom, Auto Focus
H.265/H.265+/H.264/H.264+
IR LEDs up to 66ft,
Auto Intensity Adjustment
Pan 0° to 330°, Tilt 0° to 90°
True WDR 120dB, 3D DNR,
HLC, BLC, EIS
Micro SD Card Slot up to 256GB
ANR, IK10 Vandal-Proof, IP66
Lightning/Surge Protection
Two Way Audio
DC 12V, PoE (802.3 af) Max 12W
2.5" (Φ) Outdoor/Indoor,
PoE Injector and Wall Mount
(LTB202) Sold Separately

OCB-3EF3B404IW

4MP HD, 1/3" CMOS
0.005Lux@F1.6 Ultra Low Light
2560x1440P@25fps
2.8 - 12mm, Two Way Audio
4x Optical Zoom, Auto Focus
H.265/H.265+/H.264/H.264+
IR LEDs up to 66ft
Auto Intensity Adjustment
Pan 0° to 330°, Tilt 0° to 90°
True WDR 120dB, 3D DNR,
HLC, BLC, EIS
Micro SD Card Slot up to 256GB
ANR, IK10 Vandal-Proof,
IP66, Lightning/Surge Protection
DC 12V, PoE (802.3 af) Max 12W
2.5" (Φ) Outdoor/Indoor
PoE Injector and Wall Mount
(LTB202) Sold Separately

OCB-2EF5320W-AE3



2.1MP, Full HD 1080P
1/2.8" CMOS, 0.05Lux@F1.6
1920x1080P@30fps
4.7 - 94mm, H.264/H.264+
20x Optical Zoom, Auto Focus
3D Zoom, 3D Privacy Masking
5° to 90°(Auto-flip), ANR
Digital WDR, 3D DNR,
HLC, BLC, Defog, EIS
Audio I/O, Alarm I/O
Micro SD Card Slot up
to 128GB,
IK10 Vandal-Proof,
Lightning/Surge Protection
AC 24V, PoE+(802.3 at)
4" (Φ), Max 18W
PoE Injector Included

OCB-3DF5B215IW-DE



2.1MP, Full HD 1080P,
1/2.8" CMOS, -5° to 90°(Auto-flip)
0.005Lux@F1.6 Ultra Low Light
1920x1080P@30fps, 5 - 75mm
15x Optical Zoom, Auto Focus
H.265/H.265+/H.264/H.264+
IR LEDs up to 164ft,
Auto Intensity Adjustment
Smart Tracking,
True WDR 120dB, 3D DNR,
HLC, BLC, Defog, EIS,
Audio I/O, Alarm I/O
Micro SD Card Slot up to 256GB,
ANR, IK10 Vandal-Proof,
IP66, DC 12V, Max 18W
Lightning/Surge Protection
PoE+(802.3 at, class4), 4" (Φ)
PoE Injector and Wall Mount
(LTB412) Sold Separately

OCB-3DF5B225IW-DE



2.1MP, Full HD 1080P,
1/2.8" CMOS, -5° to 90°(Auto-flip)
0.005Lux@F1.6 Ultra Low Light
1920x1080P@30fps, 4.8 - 120mm
25x Optical Zoom, Auto Focus
H.265/H.265+/H.264/H.264+
IR LEDs up to 164ft,
Auto Intensity Adjustment
Smart Tracking,
True WDR 120dB, 3D DNR,
HLC, BLC, Defog, EIS,
Audio I/O, Alarm I/O
Micro SD Card Slot up to 256GB,
ANR, IK10 Vandal-Proof,
IP66, DC 12V, Max 18W
Lightning/Surge Protection
PoE+(802.3 at, class4), 4" (Φ)
PoE Injector and Wall Mount
(LTB412) Sold Separately

OCB-3DF5B425IW-DE



4MP HD, 1/2.5" CMOS
0.005Lux@F1.6 Ultra Low Light
2560x1440@30fps, 4.8 - 120mm
25x Optical Zoom, Auto Focus
H.265/H.265+/H.264/H.264+
IR LEDs up to 164ft
Auto Intensity Adjustment
Smart Tracking
-5° to 90°(Auto-flip), Audio I/O
True WDR 120dB, 3D DNR,
HLC, BLC, Defog, EIS, 4" (Φ)
Alarm I/O, DC 12V, IP66, ANR
Micro SD Card Slot up to 256GB
IK10 Vandal-Proof, PoE+
(802.3 at, class4), Max 18W
Lightning/Surge Protection
PoE Injector and Wall Mount
(LTB412) Sold Separately



Smart Tracking

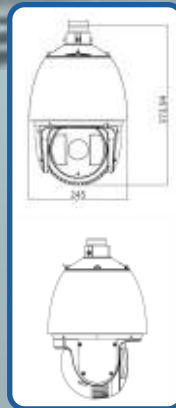

KEY FEATURES

- Smart Tracking 2.0
- Super Low Light
- Human/Vehicle Detection powered by Deep Learning
- 120dB True WDR

OCB-3EF8325IX-AEL

2.1MP, Full HD 1080P, 1/2.8" CMOS
 0.002Lux@F1.2 Ultra DarkSight
 1920x1080P@60fps, 4.8 - 120mm
 25x Optical Zoom, Auto Focus, Smart Tracking 2.0
 H.265/H.265+/H.264/H.264+
 IR LEDs up to 492ft, Auto Intensity Adjustment
 Human/Vehicle Detection powered by Deep Learning
 -10° to 90°(Auto-flip)
 120dB True WDR, 3D DNR, HLC, BLC, Defog, EIS
 Audio I/O, Alarm I/O
 Micro SD Card Slot up to 64GB, ANR
 IP66, Lightning Protection, Surge Protection
 AC 24V(Max 50W), High PoE(Max 60W)
 7" (Φ)
 High PoE Injector(60W) and Wall Mount Bracket
 (LTB762N) Sold Separately

OCB-3EF5225IW-DE



2.1MP, Full HD 1080P
 1/2.8" CMOS, 0.02Lux@F1.6
 1920x1080P@30fps
 4.7 - 94mm, 20x Optical Zoom
 3D Zoom, 3D Privacy Masking
 H.264/H.264+, Auto Focus
 IR LEDs up to 492ft, BNC Output
 Auto Intensity Adjustment
 -15° to 90°(Auto-flip)
 Digital WDR, 3D DNR, HLC,
 BLC, Defog, EIS, Audio I/O, Alarm I/O
 Micro SD Card Slot up to 128GB, ANR
 IP66, Lightning Protection, AC 24V
 High PoE, Max 32W, Surge Protection
 5" (Φ)
 High PoE Injector and Wall Mount
 Bracket Included

OCB-3DF6425IW-AE



4MP HD, 1/2.8" CMOS
 0.005Lux@F1.6 Ultra Low Light
 2560x1440@30fps/1920x1080P@60fps
 4.8 - 120mm, Smart Tracking
 25x Optical Zoom, Auto Focus
 H.265/H.265+/H.264/H.264+
 IR LEDs up to 492ft, Alarm I/O
 -15° to 90°(Auto-flip), Audio I/O
 Auto Intensity Adjustment
 True WDR 120dB, 3D DNR, HLC,
 BLC, Defog, EIS, ANR
 Micro SD Card Slot up to 256GB
 IP66, Lightning Protection,
 Surge Protection, AC 24V,
 High PoE Max 40W, 5" (Φ)
 High PoE Injector(60W) and Wall
 Mount Bracket (LTB762N) Sold
 Separately

OCB-2DE7232IW-AE



2.1MP, Full HD 1080P
 1/2.8" CMOS, 4.8 - 153mm
 0.005Lux@F1.6 Ultra Low Light
 1920x1080P@60fps
 32x Optical Zoom, Auto Focus
 H.265/H.265+/H.264/H.264+
 IR LEDs up to 492ft, Smart Tracking
 Auto Intensity Adjustment
 -15° to 90°(Auto-flip)
 True WDR 120dB, 3D DNR, HLC,
 BLC, Defog, EIS, Audio I/O
 Alarm I/O, ANR, High PoE Max 40W
 Micro SD Card Slot up to 256GB,
 IP66, Lightning Protection,
 Surge Protection, AC 24V, 7" (Φ)
 High PoE Injector(60W) and Wall
 Mount Bracket (LTB762N) Sold
 Separately

OCB-2DE4223W-DE	OCB-2DE4225W-DE	OCB-3EF5225IW-DE
		
	  	  
<p>2.1MP, Full HD 1080P 1/3" CMOS, 0.05Lux@F1.6 1920x1080P@30fps, 4 - 92mm 23x Optical Zoom, Auto Focus 3D intelligent positioning Privacy Masking 0° to 90°(Auto-flip) Digital WDR, 3D DNR, BLC, EIS Alarm I/O, BNC Output IK8, IP66, Lightning Surge Protection AC 24V, Max 18W, 4" (Φ) Wall Mount Bracket Included</p>	<p>2.1MP, Full HD 1080P 1/2.8" CMOS, 1920x1080P@30fps 0.005Lux@F1.6 Ultra Low Light 4.8 - 120mm, 5° to 90°(Auto-flip) 25x Optical Zoom, Auto Focus 3D intelligent positioning Privacy Masking, AC 24V True WDR 120dB, 3D DNR, BLC, EIS, Alarm I/O, Max 20W IK10, IP66, Lightning Surge Protection 4" (Φ) Wall Mount Bracket Included</p>	<p>2.1MP, Full HD 1080P 1/2.8" CMOS, 4.8 - 120mm 0.005Lux@F1.6 Ultra Low Light 1920x1080P@30fps 25x Optical Zoom, Auto Focus IR LEDs up to 492ft Auto Intensity Adjustment 3D intelligent positioning Privacy Masking, Alarm I/O -15° to 90°(Auto-flip) True WDR 120dB, 3D DNR, BLC, EIS, IP66, Lightning Surge Protection, AC 24V Max 30W, 5" (Φ) Wall Mount Bracket Included</p>

PTZ Accessories

Model	OCB-KB1007	OCB-1005KI	OCB-PSE802F-E	OCB-PSE802F	OCB-PSE802F-60W
Image					
Connection Type	RS485	USB	PoE + (30W)	PoE + (30W)	High PoE (60W)
Compatible Model	TVI PTZs and Analog PTZs PTZIP762X20IR	NVR/DVR NVMS7000 PC Software			
Model	OCB-615BRA	OCB-1602ZJ-E	OCB-1412J-E	OCB-B276ZCM	OCB-B275ZPM
Image					
Specs.	Wall Mount Bracket for PTZIP20x	Wall Mount for PTZ51xx/PTZ76xx/ PTZ77xx	Wall mount bracket for PTZ41xx	Corner Mount	Pole Mount
Model	OCB-229	OCB-229LGR	OCB-1661ZJ	OCB-1661ZJ-50	OCB-1660ZJ
Image					
Specs.	Pendant Mount 7.8" (20cm) for PTZIP20xx	Pendant Mount 7.8" (200cm) for PTZIP20xx	Pendant Mount 7.8" (20cm)	Pendant Mount 20" (50cm)	Parapet Wall Mount

15 in DVR

Supports all Video Formats

IP Up to 4K/8MP

AHD Up to 5MP

HD-TVI Up to 4K/8MP

HD-CVI Up to 4MP

ANALOG
Up to 960H/WD1/
1000TVL











A/B Mini 1U Case



C/D Compact Case

Advanced Level

	A  	B  	C  	D   
Model N°	OCB-8304IRKI-J1	OCB-8308IQKI-J1	OCB-8308IQKI-J2	OCB-83016QKI-J2
Analog Video Input	4CH (TVI3.0/AHD /CVI/960H) Channel 1 up to 3MP	8CH (TVI3.0/AHD/CVI/960H) Channel 1&2 up to 3MP		16CH (TVI3.0/AHD/ CVI/960H) Channel 1-4 up to 3MP
Record Data	1080P@15fps, CH 1 up to 3MP@15fps	1080P@15fps, CH 1&2 up to 3MP@15fps		1080P@15fps, CH 1-4 up to 3MP@15fps
IPC Output	1CH up to 4MP@20fps	2CH up to 4MP@20fps		
Decoding Format	H.265 / H.265+ / H.264 / H.264+			
Video Output	VGA/HDMI up to 1920x1080P, CVBS		HDMI up to 4K (3840x2160)/ VGA up to 1080P, CVBS	
Playback Channel	4CH	8CH	16CH	
Audio In/Out	1CH/1CH, RCA			
Network	10/100Mbps		10/100Mbps	
Storage	1SATA up to 6TB, NAS, IP SAN		2SATA up to 12TB, NAS, IP SAN	
eSATA				
USB	2, USB 2.0		1 USB 2.0, 1 USB 3.0	
PTZ	1 RS485			
Dimensions	12.4"(W)x9.1"(D)x1.8"(H)		15"(W)x12.4"(D)x1.8"(H)	



HD-TVI DVR



Smart DVR

AI for any TVI cameras

Accurate detection of human and vehicle, over 100 times more accurate than regular motion detection
Smart and efficient video search, save hours on searching playback footage



Professional Level

	F	G	H	I	J
Model N°	OCB-8204JUJI-L1	OCB-7204HTHI-K1	OCB-8208JUJI-L2	OCB-7208HTHI-K2	OCB-7216HTHI-K2
Analog Video Input	4CH (HD-TVI4.0/AHD/CVI/960H)		8CH (HD-TVI4.0/AHD/CVI/960H)		16CH (HD-TVI4.0/AHDCVI/960H)
Record Rate	5MP@12fps, 4MP@15fps, 3MP@18fps, 1080P@30fps		8MP@8fps, 5MP@12fps, 4MP@15fps, 3MP@18fps, 1080P@30fps		
IPC Output	2CH, Up to 6MP (3072x2048)			4CH, Up to 4K, 8 MP (3840x2160)	2CH, Up to 6MP (3072x2048)
Decoding Format	H.265 / H.265+ / H.264 / H.264+				
Video Output	HDMI/VGA up to 1080P, CVBS		HDMI/VGA up to 1080P, CVBS		
Deep Learning Supp.	4CH Human/Vehicle Detection		4CH Human/Vehicle Detection		
Playback Channel	4CH		8CH		16CH
Audio In/Out	1CH/1CH, RCA				
Alarm In/Out	4/1		8/4		16/4
Network	10/100/1000Mbps				
Storage	1SATA up to 10TB, NAS, IP SAN		2SATA up to 20TB, NAS, IP SAN		
USB	2, USB 2.0		1 USB 2.0, 1 USB 3.0		
PTZ	1 RS485				
Support POS					2(TCP)
Dimensions	12.4"(W)x9.1"(D)x1.8"(H)		15"(W)x12.4"(D)x1.8"(H)		



















Enterprise Level

	A	B	C	D
Model N°	OCB-8424IRKI-J4	OCB-8432IRKI-J4	OCB-9224IRKI-J8	OCB-9232IRKI-J8
Analog Video Input	24CH (HD-TVI 2.0)	32CH (HD-TVI 2.0)	24CH (HD-TVI 2.0)	32CH (HD-TVI 2.0)
Record Rate	1080P@15fps, 720P@20ps			
IPC Output	Up to 8CH 1080P@30fps		Up to 16CH 1080P@30fps	
Decoding Format	H.264 / H.264+			
Video Output	VGA/HDMI up to 1920x1080P, CVBS		HDMI up to 4K (3840x2160)/ VGA up to 1080P, CVBS	
Playback Channel	24CH	32CH	24CH	32CH
Audio In/Out	4CH/1CH, RCA		16CH/1CH, RCA	
Alarm In/Out	16/4		16/8	
Network	10/100/1000Mbps		10/100/1000Mbps, 2RJ45	
Storage	4SATA up to24TB, NAS, IP SAN		8SATA up to48TB, NAS, IP SAN	
eSATA	1			
USB	3, USB 2.0			
PTZ	1 RS485			
Support POS	8 (TPC)		16 (TPC)	
Dimensions	17.5"(W)x15.9"(D)x2.8"(H)		17.5"(W)x18.9"(D)x3.5"(H)	



Enterprise Level

	E    	F    	G    	H    
Model N°	OCB-8416JUJI-J4	OCB-8424JUJI-J4	OCB-8432JUJI-J4	OCB-9432JUJI-J8
Analog Video Input	16CH (HD-TVI4.0/ AHD/CVI/960H)	24CH (HD-TVI4.0/ AHD/CVI/960H)	32CH (HD-TVI4.0/ AHD/CVI/960H)	
Record Rate	8MP@8fps, 5MP@12fps, 4MP@15fps, 3MP@18fps, 1080P@30fps			
IPC Output	2CH up to 4K/8MP (3840x2160), adjustable up to 18CH	8CH up to 4K/8MP (3840x2160), adjustable up to 32CH	8CH up to 4K/8MP (3840x2160), adjustable up to 40CH	32CH up to 12MP (4000x3072), adjustable up to 64CH
Decoding Format	H.265 / H.265+ / H.264 / H.264+			
Video Output	HDMI1/VGA up to 1920x1080P, HDMI2 up to 4K (3840x2160), CVBS (704x480)			
Playback Channel	16CH			
Audio In/Out	4CH/2CH, RCA	4CH/1CH, RCA		16CH/1CH, RCA
Alarm In/Out	16/4			16/8
Network	10/100/1000Mbps, 2 RJ45			
Storage	4SATA up to 40TB, NAS, IP SAN, RAID 0, 1, 5, 6 and 10 HOT SWAP			8SATA up to 80TB, NAS, IP SAN, RAID 0, 1, 5, 6 and 10 HOT SWAP
eSATA	1			
USB	2, USB 2.0, 1 USB 3.0			
PTZ	RS-485 (FULL DUPLEX), KEYBOARD			
Support POS	4 (TPC or RS232)	8 (TPC or RS232)		
Dimensions	17.5"(W)x15.3"(D)x2.8"(H)			17.4"(W)x18.5"(D) x3.5"(H)

OCB-3DF82DFT-F	OCB-3DF20DFT-F	OCB-3DF22DFT-F
		
<p>2.1MP Full HD 1080P 3.6mm Fixed Lens 1920x1080P@30fps 0.0005 Lux@F1.0 Clear White LEDs up to 65ft True WDR 120dB TVI/AHD/CVI/960H Switchable IP67</p>	<p>2.1MP Full HD 1080P 3.6mm Fixed Lens 1920x1080P@30fps 0.0005 Lux@F1.0 Clear White LEDs up to 65ft True WDR 120dB TVI/AHD/CVI/960H Switchable IP67</p>	<p>2.1MP Full HD 1080P 3.6mm Fixed Lens 1920x1080P@30fps 0.0005 Lux@F1.0 Clear White LEDs up to 131ft True WDR 120dB TVI/AHD/CVI/960H Switchable IP67</p>

Colors at Night

24/7 Color Image
Ultra Low Lux
White lighting compensation



◆ HD-TVI Turret Camera

A/C

B/D

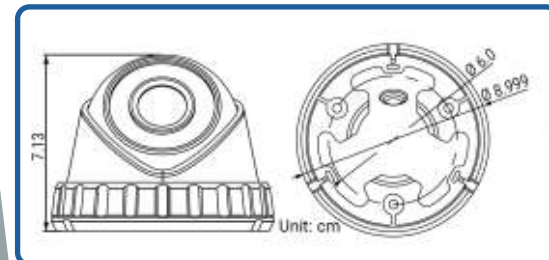

A OCB C9024-TVI2 MP-EC

2.1MP Full HD 1080P
2.8mm Fixed Lens
1920x1080P@30fps
0.01 Lux, Smart IR
TVI/AHD/CVI/960H
Switchable
IP66

B OCB C9024-TVI2 MP-ECB

2.1MP Full HD 1080P
2.8mm Fixed Lens
1920x1080P@30fps
0.01 Lux, Smart IR
TVI/AHD/CVI/960H
Switchable, IP66
Black Housing

C OCB C9024-TVI2 MP-EC3

2.1MP Full HD 1080P
3.6mm Fixed Lens
1920x1080P@30fps
0.01 Lux, Smart IR
TVI/AHD/CVI/960H
Switchable, IP66
Black Housing

D OCB C9024-TVI2 MP-ECB3

2.1MP Full HD 1080P
3.6mm Fixed Lens
1920x1080P@30fps
0.01 Lux, Smart IR
TVI/AHD/CVI/960H
Switchable, IP66
Black Housing

KEY FEATURES

- ◆ High Definition Fixed Lens Turret HD-TVI Camera
- ◆ 2.1MP
- ◆ 24 IR LEDs up to 65ft



E

H

F/G



E OCB-C9024 TVI-2 MP-TWR

2.1MP Full HD 1080P
2.8mm Fixed Lens
1920x1080@30fps
24 IR LEDs up to 65ft
True WDR 120dB
IP66



**F OCB-3DF67E9U-ITM
OCB-3DF67E9U-ITM -36**

2.1MP Ultra Low Light
2.8/3.6mm Fixed Lens
1920x1080@30fps
0.005 Lux@F2.0
2 Matrix IR 2.0 LEDs
up to 65ft, IP67
True WDR 120dB



**G OCB-3DF5710T-ITMF
OCB-3DF5710T-ITMF-36**

5MP High Definition
2.8/3.6mm Fixed Lens
2560x1944@20fps
0.01 Lux, Smart IR
2 Matrix IR 2.0 LEDs up
to 65ft, IP67
TVI/AHD/CVI/960H
Switchable



H OCB-3DF87V8U-ITMF

8.3MP 4K UHD
2.8mm Fixed Lens
3840x2160@12.5fps
0.01 Lux
Matrix IR up to 65ft,
Smart IR
TVI/AHD/CVI/960H
Switchable
IP67



KEY FEATURES

- High Definition Fixed Lens Turret HD-TVI Camera
- 2.1MP/5MP/4K(8MP)

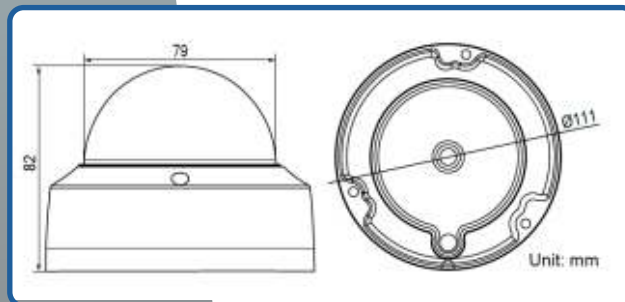

OCB-1272ZJ-110-TRS



Wall Mount

OCB-1280ZJ-XS



Universal Junction Box

OCB-1280ZJ-XSB

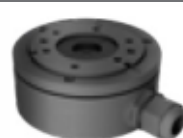

Universal Junction Box (Black)

OCB-B275ZPM



Pole Mount

OCB-B276ZCM



Corner Mount

A OCB-D9020 TVI 2MP

2.1MP Full HD 1080P
2.8mm Fixed Lens
1920x1080P@30fps
Smart IR
IP66

**B OCB E9034 TVI 2 MP
OCB E9034B TVI 2 MP**

2.1MP Full HD 1080P
2.8mm Fixed Lens
1920x1080P@30fps
0.01 Lux, Smart IR
TVI/AHD/CVI/960H
Switchable, IP66
White or Black
Housing



**C OCB E9034 TVI 2 MP36
OCB D9020 TVI 2MP36**

2.1MP Full HD 1080P
3.6mm Fixed Lens
1920x1080P@30fps
0.01 Lux, Smart IR
TVI/AHD/CVI/960H
Switchable IP66



**D OCB E9034W TVI 2 MP
OCB E9034W TVI 2 MP36**

2.1MP Ultra Low Light
2.8mm/3.6mm Fixed Lens
1920x1080@30fps
0.005 Lux@F2.0
2 Matrix IR 2.0 up to 131ft
True WDR 120dB
IP66



**E OCB-3DF6710T-IT1F
OCB-3DF6710T-IT1F36**

5MP High Definition
2.8mm/3.6mm Fixed Lens
2560x1944@20fps
0.01 Lux, Smart IR
2 Matrix IR 2.0 up to 131ft
TVI/AHD/CVI/960H
Switchable, IP67



F OCB-3DF6710TW-IT1F

2.1MP Full HD 1080P
2.8mm Fixed Lens
1920x1080@30fps
24 IR LEDs up to 65ft
True WDR 120dB
IP66



KEY FEATURES

- High Definition Fixed Lens Turret HD-TVI Camera
- 2.1MP/5MP/4K(8MP)

OCB-1273ZJ-130-TRL	OCB-1280ZJ-M	OCB D9020 JB	OCB-B275ZPM	OCB-B276ZCM	OCB-1271ZJ-130TRL
Wall Mount	Junction Box	Junction Box	Pole Mount	Corner Mount	Pendant Mount

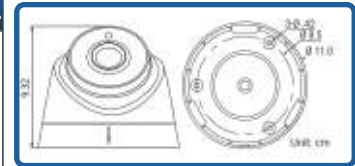

HD-TVI Turret Camera

KEY FEATURES

- High Definition Varifocal Turret HD-TVI Camera
- 2MP/5MP/4K(8MP)



**G OCB-3DE67E1T-VFIR
OCB-3DE67E1T-VFIRB**

2.1MP Full HD 1080P
2.8-12mm Varifocal Lens
1920X1080P@30fps
42 IR LEDs up to 131ft
IP66
White or Black Housing

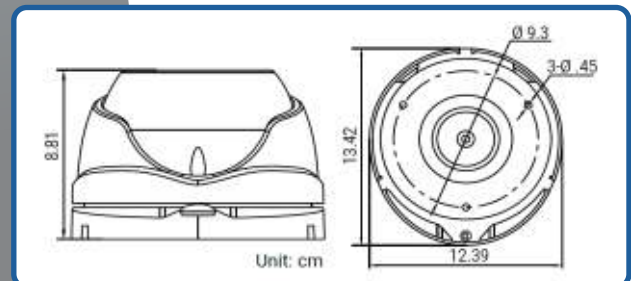

H OCB-C9020VF-TVI-2MP-TWDR

2.1MP Full HD 1080P
2.8-12mm Varifocal
Motorized Lens, IP67
1920x1080P@30fps
0.01Lux, Smart IR
True WDR 120dB
6 Matrix IR 2.0
up to 131ft



I OCB-2CE56D8T-IT3ZF

2.1MP Ultra Low Light
2.8-12mm Varifocal
Motorized Lens, Auto Focus,
IP67, 1920x1080@30fps
0.005 Lux@F1.8
True WDR 120dB
6 Matrix IR 2.0
up to 131ft



J OCB-2CE56D8T-IT3ZF

3MP High Definition
2.8-12mm Varifocal
Motorized Lens, IP67
1920x1536P@18fps
0.01Lux, Smart IR
6 Matrix IR 2.0
up to 131ft

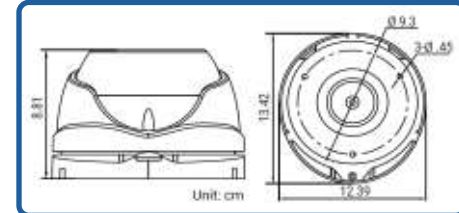

K OCB-C9020-TVI-3MP-TWDR

5MP High Definition
2.7-13.5mm Varifocal
Motorized Lens, IP67
2560x1944@20fps
0.01 Lux, Smart IR
2 Matrix IR 2.0 LEDs
up to 131ft
TVI/AHD/CVI/
960H Switchable



L OCB-3DF6710U-IT3F

8.3MP 4K UHD
2.7-13.5mm Varifocal
Motorized Lens, IP67
Auto Focus, Switchable
3840x2160@12.5fps
0.01 Lux, Smart IR
2 Matrix IR 2.0 LEDs
up to 131ft
TVI/AHD
CVI/ 960H



H/I/J

K/L



KEY FEATURES

- High Definition Varifocal Turret HD-TVI Camera
- 2MP/5MP/4K(8MP)

OCB-1280ZJ-M	OCB-1273ZJ-130-TRL	OCB-B275ZPM	OCB-B276ZCM
Junction Box	Wall Mount	Pole Mount	Corner Mount



The advantage of a 4K camera over a standard HD 1080p camera is that you get four times higher resolution from the 4K camera. This means you could either install one 4K camera in place of a few 1080p cameras or replace an existing 1080p camera with a 4K camera to get much more detail in a covered area. The density of the image allows for image zooming (real time or recorded video) that gives four times the detail as a 1080p HD camera, making a response to an incident much more effective.

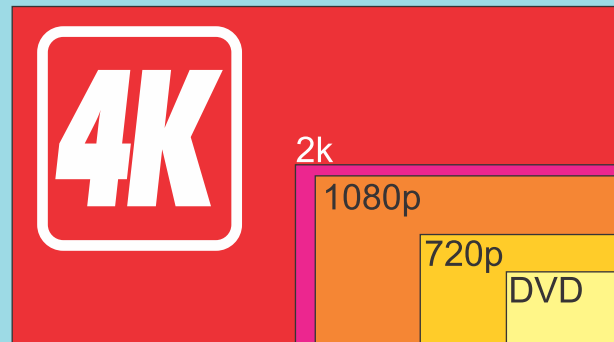

A/B/C



A OCB- HD5020

2.1MP Full HD 1080P
2.8mm Fixed Lens
1920x1080P@30fps
18 IR LEDs up to 65ft,
Smart IR
IP66, IK10
3-Axis
Easy Installation

B OCB- HD5020-36

2.1MP Full HD 1080P
2.8mm Fixed Lens
1920x1080P@30fps
18 IR LEDs up to 65ft,
Smart IR
IP66, IK10
3-Axis
Easy Installation

**C OCB- HD5020B
OCB- HD5020B-36**

2.1MP Full HD 1080P
2.8mm Fixed Lens
1920x1080P@30fps
18 IR LEDs up to 65ft,
Smart IR, IP66, IK10
3-Axis Easy Installation
Black Housing

D OCB-3DF67E8T-VPITF

2.1MP Ultra Low Light
2.8mm Fixed Lens, IK10
1920x1080@30fps, IP67
0.005 Lux@F2.0
2 Matrix IR 2.0
LEDs up to 65ft
True WDR
120dB



E OCB-3DF67E8T-VPITF36

2.1MP Ultra Low Light
3.6mm Fixed Lens, IP67
1920x1080@30fps, IK10
0.005 Lux@F2.0
2 Matrix IR 2.0
LEDs up to 65ft
True WDR
120dB



F OCB-3DF6710U-VPIT

5MP High Definition
2.8mm Fixed Lens
2560x1944@20fps
0.01 Lux, Smart IR
2 Matrix IR 2.0
LEDs up to 65ft
IP67, IK10

D/E/F/G/H/I



G OCB-3DF6710U-VPITF

5MP High Definition
2.8mm Fixed Lens, IP67
2560x1944@20fps, IK10
0.01 Lux, Smart IR
2 Matrix IR 2.0
Switchable
LEDs up to 65ft
TVI/AHD/CVI/960H



H OCB-3DF6819U-VPITF

5MP Ultra Low Light
2.8mm Fixed Lens
2560x1944@20fps
0.008 Lux@F1.2
2 Matrix IR 2.0
LEDs up to 65ft
IP67, IK10



I OCB- 3DF68V1U-VPITF

8.3MP 4K UHD
3.6mm Fixed Lens
3840x2160@12.5fps
0.01 Lux, Smart IR
Matrix IR up to 65ft
Smart IR
IP67, IK10

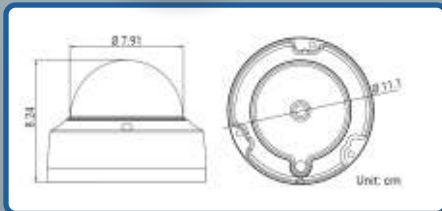

KEY FEATURES

- High Definition Fixed Lens Dome HD-TVI Camera
- 2.1MP/5MP/4K(8MP)

OCB-B275ZPM	OCB-B276ZCM	OCB-1272ZJ-110	OCB-1272ZJ-110B	OCB-1271ZJ-135
Pole Mount	Corner Mount	Wall Mount	Wall Mount	Pendant Mount
OCB-1280ZJ-DM18	OCB-1259ZJ	OCB-1258ZJ		
Junction Box	Angled Base (150)	Wall Mount		

J OCB-3DF67E0U-VPI3F

2.1MP Full HD 1080P
2.8-12mm Varifocal Lens
1920X1080P@30fps
24 IR LEDs up to 131ft
3-Axis Easy Installation
IP66, IK10
•Dual Voltage,
DC12V/AC24V

K OCB-2CE56D8T-AVPIT3Z

2.1MP Ultra Low Light
2.8-12mm VFMotorized
Lens, Auto Focus, IP67
1920x1080@30fps, IK10
0.005 Lux@F2.0
2 Matrix IR 2.0
LEDs up to 131ft
True WDR
120dB

L OCB-617D-5MP

5MP High Definition
2.8-12mm VF Motorized
Lens, 2560x1944@20fps
0.01 Lux, Smart IR
2 Matrix IR 2.0
LEDs up to 131ft
3-Axis, Easy Installation
IP67, IK10

M OCB-2CE5AH0T-AVPIT3ZF

5MP High Definition
2.7-13.5mm VF, IP67
Motorized Lens, IK10
2560x1944@20fps
0.01 Lux, Smart IR
2 Matrix IR 2.0
LEDs up to 131ft
TVI/AHD/CVI/960H
Switchable

N OCB-3DF60I9U-AVPI3ZF

5MP Ultra Low Light
2.7-13.5mm VF, IP67
Motorized Lens, IK10
Auto Focus, 3-Axis
2560x1944@20fps
0.008 Lux@F1.2
2 Matrix IR 2.0
LEDs
up to 131ft
Easy Install

O OCB-3DF60V1U-AVPIT3ZF

8.3MP 4K UHD
2.7-13.5mm VF, IP67
Motorized Lens, IK10
Auto Focus, Switchable
3840x2160@12.5fps
0.01 Lux, Smart IR
2 Matrix IR 2.0
LEDs up to 131ft
TVI/AHD/
CVI/960H



KEY FEATURES

- High Definition Fixed Lens Dome HD-TVI Camera
- 2.1MP/5MP/4K(8MP)

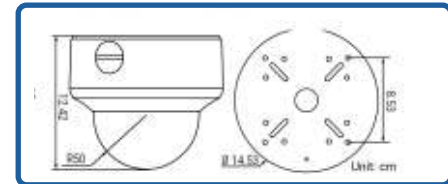

OCB-B275ZPM	OCB-B276ZCM	OCB-1273ZJ-135B	OCB-1273ZJ-135	OCB-1271ZJ-135	OCB-B227ZICM
Pole Mount	Corner Mount	Wall Mount	Wall Mount	Pendant Mount	In-Ceiling Mount

H.265+IP Cameras

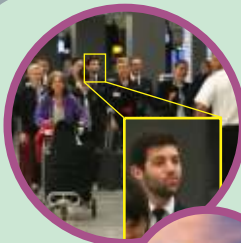

8.0MP/4K Resolution
Get the details you need, such as facial recognition and licence plate identification, with 8.0MP Resolution@ 20fps and 2560x1920@30fps.

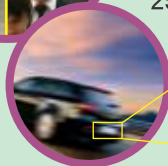

Sony STARVIS Low-Lux Chipsets

Sony STARVIS 0.005 lux sensors are specifically designed to enhanced clarity in low light environments. offering color image in nighttime applications.

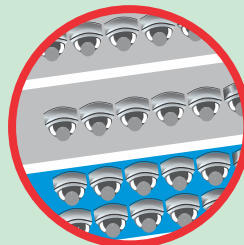

Cut your Bandwidth and Storage Needs in HALF

H.265+ is the latest and greatest video compression format, providing superior improvements in image quality and bandwidth



HD-TVI PIR Camera

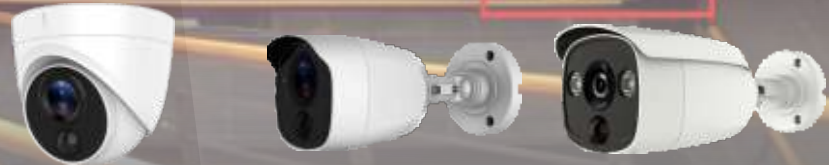

PIR SOLUTIONS

Detect. Capture. Alert.

Detect human movement with PIR sensor
Filter out false alarms to save playback time
Deliver more details with white light compensation
Flashing light helps prevent further intrusion

A OCB-2CE71H0T-PIRL

5MP High Definition
2.8mm Fixed Lens
2560x1944@20fps
0.01 Lux, Smart IR
Matrix IR 2.0 up to 65ft
PIR Motion Sensor
IP67

B OCB-2CE11H0T-PIRL

5MP High Definition
2.8mm Fixed Lens
2560x1944@20fps
0.01 Lux, Smart IR
Matrix IR 2.0 up to 65ft
PIR Motion Sensor
IP67

C OCB-2CE12H0T-PIRL

5MP High Definition
2.8mm Fixed Lens
2560x1944@20fps
0.01 Lux, Smart IR
Matrix IR 2.0 up to 65ft
PIR Motion Sensor
IP67
Junction Box Included

HD-TVI Fisheye Camera



D OCB-52H1T-FITS

5MP HD Fisheye
1.1mm Fixed Lens
2592x1944@12.5fps
0.01 Lux, Smart IR
3 Matrix IR 2.0 up to 65ft
Built-in Microphone
DC12V
IP67

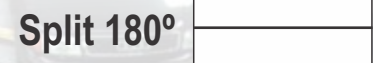
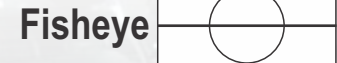

OCB-615BRA	OCB-1281ZJ-DM27	OCB-203X	OCB-1299ZJ
Wall Mount	Angled Base (15°)	Pendant Mount 7.8" (20cm)	Pendant Mount 7.8" (200cm)



A

**A OCB 644ML TVI2 MP
OCB 644ML TVI2 MPB**

2.1MP Full HD 1080P
3.6mm Fixed Lens
1920x1080P@30fps
24 IR LEDs up to 65ft
IP66
White/Black Housing

B OCB 644ML TVI2 MPW

2.1MP Full HD 1080P
3.6mm Fixed Lens
1920x1080P@30fps
2 Matrix IR up to 65ft
True WDR 120dB
IP66



C OCB 644ML TVI2 MPW36

2.1MP Ultra Low Light
3.6mm Fixed Lens
1920x1080P@30fps
2 Matrix IR up to 65ft
True WDR 120dB
IP66



B/C/D/E/F



D OCB-2CE16H0T-ITF

5MP High Definition
.8mm Fixed Lens
2560x1944@20fps
0.01 Lux, Smart IR
2 Matrix IR 2.0 up to 65ft
TVI/AHD/CVI/960H
Switchable
IP67



E OCB-2CE16H0T-ITF36

5MP High Definition
3.6mm Fixed Lens
2560x1944@20fps
0.01 Lux, Smart IR
2 Matrix IR 2.0 up to 65ft
TVI/AHD/CVI/960H
Switchable
IP67



F OCB-2CE16U1T-IT5F

8.3MP 4K UHD
2.8mm Fixed Lens
3840x2160@12.5fps
0.01 Lux, Smart IR
Matrix IR up to 65ft
TVI/AHD/CVI/960H
Switchable
IP67



KEY FEATURES

- High Definition Fixed Lens Dome HD-TVI Camera
- 2.1MP/5MP/4K(8MP)

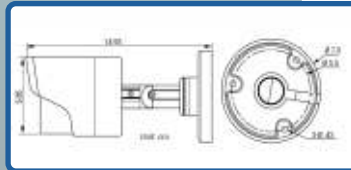

OCB-1280ZJ-XS



Universal Junction Box

OCB-1280ZJ-XSB



Universal Junction Box (Black)

G



H/I/J/K/L/M/N



G OCB-183-EXIR-TVI-2MP

2.1MP Full HD 1080P, 3.6mm Fixed Lens, IP66
1920x1080P@30fps, 1 Matrix IR LED up to 131ft

H OCB-3DE16E8T-IR3E

2.1MP Full HD 1080P
3.6mm Fixed Lens
1920x1080P@30fps
2 Matrix IR 2.0
up to 131ft
True WDR 120dB
IP66



I OCB-3DE16E8T-IR3E36

2.1MP Ultra Low Light
3.6mm Fixed Len
1920x1080P@30fps
2 Matrix IR 2.0
up to 131ft
True WDR 120dB
IP66



KEY FEATURES

- High Definition Fixed Lens Bullet HD-TVI Camera
- 2.1MP/5MP/4K(8MP)
- Junction Box Included

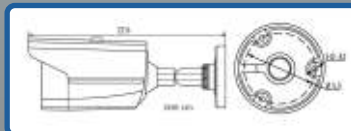

J OCB-2CE16H0T-ITF

5MP High Definition
2.8mm Fixed Lens
2560x1944@20fps
0.01 Lux, Smart IR
2 Matrix IR 2.0 up to 131ft
TVI/AHD/CVI/960H
Switchable
IP67



K OCB-2CE16H0T-ITF36

5MP High Definition
3.6mm Fixed Lens
2560x1944@20fps
0.01 Lux, Smart IR
2 Matrix IR 2.0 up to 131ft
TVI/AHD/CVI/960H
Switchable
IP67



L OCB-2CE16H0T-ITF6

5MP High Definition
6mm Fixed Lens
2560x1944@20fps
0.01 Lux, Smart IR
2 Matrix IR 2.0 up to 131ft
TVI/AHD/CVI/960H
Switchable
IP67



M OCB-2CE16H0T-ITFW

5MP Ultra Low Light
2.8mm Fixed Lens
2560x1944@20fps
0.003 Lux@F1.2
2 Matrix IR 2.0 up to 131ft
True WDR 120dB
TVI/AHD/CVI/960H
Switchable
IP67



N OCB-2CE16H0T-ITFW36

8.3MP 4K UHD
2.8mm Fixed Lens
3840x2160@12.5fps
0.01 Lux, Smart IR
Matrix IR up to 131ft
TVI/AHD/CVI/960H
Switchable
IP67



A OCB-3DF127E0T-VFIR3F

2.1MP Full HD 1080P
2.8-12mm Varifocal Lens
1920x1080P@30fps, IP66
42 pcs IR LEDs up to 165ft
Dual Voltage, DC12V/AV24
Junction Box Included

B OCB-3DF127E0T-VFIR3FB

2.1MP Full HD 1080P
2.8-12mm Varifocal Lens
1920x1080P@30fps, IP66
42 pcs IR LEDs up to 165ft
Dual Voltage, DC12V/AV24V
Junction Box Included



A



B



C OCB-192-EXIR-VF-TVI-2MP

2.1MP Full HD 1080P
2.8-12mm Varifocal Lens
0.014 Lux, Smart IR, IP66
1920x1080P@30fps
1 Matrix IR LED up to 175ft
True WDR 120dB
CVBS Output, Dual Voltage
DC12V/AC24V
Junction Box
Included



D OCB-2CE16D8T-AIT3Z

2.1MP Ultra Low Light
2.8-12mm Varifocal
Motorized Lens, Auto Focus
1920x1080@30fps, IP67
0.005 Lux@F2.0
6 Matrix IR 2.0 LEDs up to
131ft, True WDR 120dB
Dual Voltage, DC12V/AC24V
Junction Box
Included



E OCB-2CE16H0T-AIT3ZF

5MP High Definition
2.7-13.5mm Motorized
Varifocal Lens, Auto Focus
2560x1944@20fps, IP67
0.01 Lux, Smart IR
2 Matrix IR 2.0 up to 131ft
TVI/AHD/CVI/960H
Switchable Dual Voltage,
DC12V/AC24V
Junction Box
Included



F OCB-2CE19U1T-AIT3ZF

8.3MP 4K UHD, IP67
2.7-13.5mm Varifocal
Motorized Lens, Auto Focus
3840x2160@12.5fps
0.01 Lux, Smart IR
Matrix IR up to 131ft
TVI/AHD/CVI/960H
Switchable
Dual Voltage,
DC12V/AC24V
Junction Box
Included



G OCB-195-IR-VFTVI-2MP

2.1MP Full HD 1080P
5-50mm Varifocal
Motorized Lens, Auto Focus
1920x1080P@30fps
2 Matrix IR up to 360ft
True WDR 120dB, IP66
Dual Voltage,
DV12V/AC24V
CVBS Output
Junction Box
Included



H OCB-2CE16C8T-IW3Z

1.3MP HD License Plate
Capture
6-22mm VF Motorized Lens
1280x960P@30fps
6 Clear White LEDs
up to 131ft
CVBS Output
IP66, DC12V
LTB100 Bracket
Included
Color 24/7 Mode



OCB-2102TVI-2MP	OCB-2470SD-TVI-2MP	OCB-819-IRTVI-2MP
 	 	  
<p>2.1MP Full HD 1080P 3.7mm Pinhole Lens 1920X1080P@30fps TVI/AHD/CVI/960H Switchable DC 12V</p>	<p>2.1MP Full HD 1080P 3.7mm Pinhole Lens 1920X1080P@30fps TVI/AHD/CVI/960H Switchable DC 12V</p>	<p>2.1MP Full HD 1080P 3.7mm Pinhole Lens, DC 12V 1920X1080P@30fps IR LEDs up to 50ft, Smart IR TVI/AHD/CVI/960H, Switchable</p>

Monitors/ Mounting Brackets/ Lock Boxes



Monitors come with: Remote, BNC, HDMI & VGA Inputs

DVR Mounting Brackets

DMB1 DMB2



DVR Lockboxes

**OCB-LOCKBOX185 OCB-LOCKBOX218
OCB-LBWALLMOUNT (Wall Mount Bracket)**



End-to-End Solution for Vehicle Service and VAS

OCB
electronics **LAYERED ARCHITECTURE**



ACCESS



TRANSMISSION

PLATFORM



Registration Server

CMS Server

WiFi Platform

Web Service

Central Database

SERVICES & APPLICATIONS



Surveillance



Fleet Management



Dispatch



Advertisement



Surf Internet

Fuel report
Geolocation
Services report
Test report iphone
Trips and stops

Reports

TECHNICAL ADVANTAGES



Specially designed for Vehicle



Reliable hardware design



Military standard anti-vibration



Plug & Play HDD



Powerful CMS

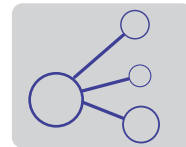

Open Protocol

OCB-ME31-08

8 Channel 1080P AHD HDD Mobile DVR



- FHD AHD MDVR
- 8ch AHD 1080p or 8ch AHD 720p
- 1 channel video& audio out. 8 ch 1080P@120fps recording
- Supports GPS, 3G, Wi-Fi.
- Built-in G-Sensor. 8 sensor in and 2 alarm out.
- 3x Rs232, 1x RS485 . USB 2.0.
- RJ45 Ethernet port.
- Support 1 x HDD/SSD.
- Max. 2TB storage. SD card.
- 8-36V DC. With VSS-ME
- Internal U-blox GPS for location tracking
- 3G/4G for live view and management
- Built-in Wi-Fi with 2 antenna (2.4G &5.8G)

MODEL		OCB-ME31-08
VIDEO	Input Output Total Resource	8 Channels 1080P / 720 AHD camera 1 Channel 8 Channel 1080p@ 120fps
AUDIO	Audio Video/Audio Compression	8 Channel input Video: H.264, Audio: ADPCM, G.711A, G.711U
RECORDING	Recording Mode Pre-Recording Post-Recording	Ignition/Manual/Schedule/Alarm (sensor, speed, acceleration video loss tempreature) Mirror recording 0-1800 seconds 0-3600 seconds
NETWORK	WiFi 3G/4G	1000/1000Mbps Ethernet port, aviation connector (RJ 45 port optional) Supports 802.11b/g/n (optional), Dual antenna available
LOCATION	GPS	Built in U-Box GPS module (optional). Location tracking, speed detection and time sync.
STORAGE	Hard Disk USB SD	Supports 2.5" hard disk up to 2TB USB 2.0 SD x 1, max 128 GB
INTERFACE	RS 232 & RS 485 Sensor G-sensor	RS 232 x 3, RS 485 x1 8 inputs, 2 outputs Built-in 3 axis G-sensor
POWER	Input	DC 8-36V
MECHANICAL	Dimention (LxWxH) Weight	197mm x 204mm x 64mm 1.8 Kg.
ENVIRONMET	Protection Operating Temperature Operating Relative Humidity	Ip54 -40°C- + 70°C (With heater) or -10°C-+ 70°C 8% - 90%

OCB-ME32-04
4 Channel AHD HDD Mobile DVR

- FHD AHD MDVR
- Supports 4 ch AHD 720P Cameras
- Modular design for easy maintenance
- Revolutionary anti-vibration technology for 360 degree installation
- Supports 2.5" 2TB hard disk,
- USB available for upgrading, and exporting videos
- Dual streams for local recording and wireless transmission
- Internal U-blox GPS for location tracking
- 3G/4G for live view and management
- Built-in Wi-Fi for auto uploading



MODEL		OCB-ME32-04
VIDEO	Input Output	4 Channels AHD/Analogue 720P camera 1 Channel
AUDIO	Audio Video/Audio Compression	4 Channel input Video: H.264, Audio: ADPCM, G.711A, G.711U
RECORDING	Recording Mode Pre-Recording Post-Recording	Ignition/Manual/Schedule/Alarm (sensor, speed, acceleration video loss tempreature) Mirror recording 0-1800 seconds 0-3600 seconds
NETWORK	Ethernet WiFi 3G/4G	1000 Mbps Ethernet port (RJ 45 port) Supports 802.11b/g/n (optional) WCDMA / EVDO / TDD-LTE / FDD-LTE (optional)
LOCATION	GPS	Built in GPS module (optional)
STORAGE	USB SD	USB 2.0 SD x 2, max 128 GB
INTERFACE	RS 232 & RS 485 Sensor	RS 232 x 3, RS 485 x1 8 inputs, 2 outputs
POWER	Input	DC 8-36V
MECHANICAL	Dimension (LxWxH) Weight	200mm x 185mm x 55mm 1.8 Kg.
ENVIRONMET	Protection Operating Temperature Operating Relative Humidity	Ip54 -20°C- + 70°C 8% - 90%

VEHICLE CAMERA

Vehicle IP Camera

- 1/3" CMOS, 1.3Megapixel
- Support ONVIF agreement
- High sensitivity, S/N CMOS sensor
- Support 10M/100M network adapt itself
- Support IR-CUT, true day/night converting
- IR view distance up to 8 meters



In vehicle IP camera



Rear View IP camera



Front View IP camera



Side View IP camera

Vehicle PTZ Camera

OCB-10-XVA5-221MRB

1/3" SONY EXview HAD-II CCD, 1 MP (1280*720)

- 22x optical zoom. 12x digital zoom, total 264x zoom
- 360° continuously pan, 0.1~220°/s pan speed
- 30°~90° tilt, 0.1~90°/s tilt speed
- 256 presets, 6 cruising routes
- Wide power range: DC11V-18v
- Built-in Osram high luminance LEDs, night view distance 50-80m
- Data memory and auto recovery after power failure
- High integrated 16bit processor: low power consumption and high stability



Roof mounting



Mounting base with sucker



PTZ joystick

OCB-10-XVA6-201MRB

Video Intercom
Support up to 500 units

Outdoor Station



Indoor Station

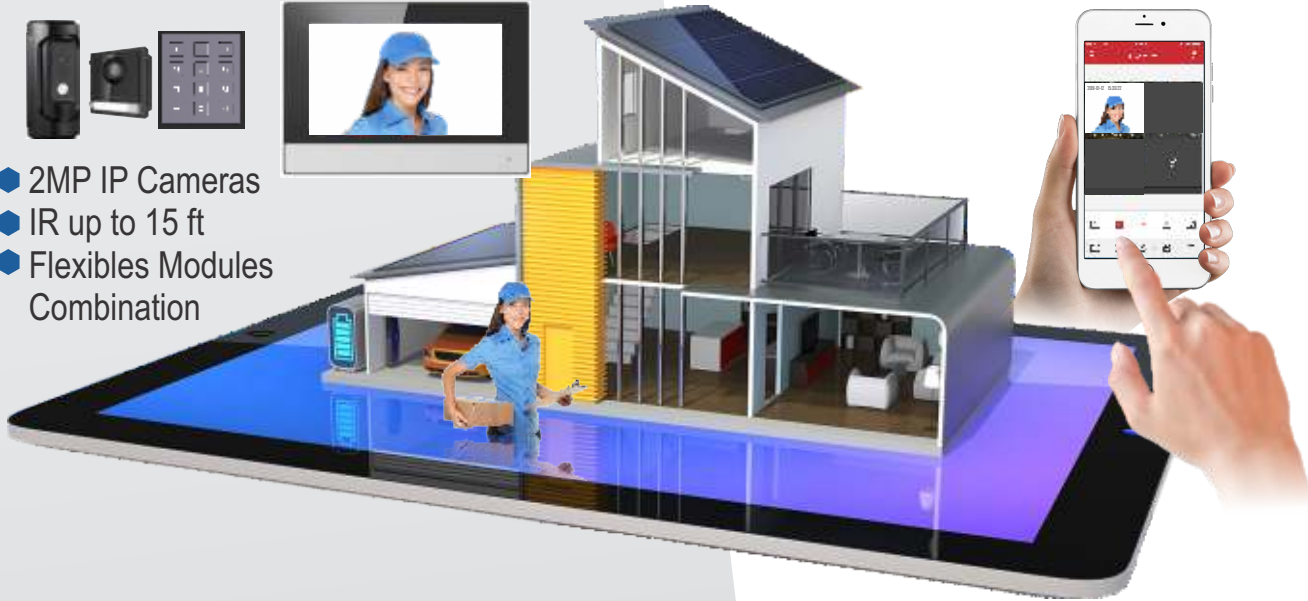

- ◆ 2MP IP Cameras
- ◆ IR up to 15 ft
- ◆ Flexibles Modules Combination

◆ Answer and unlock via mobile app remotely



Door Station		Module			
OCB-KH6310-W	OCB-KH6310-W GEN 1	OCB-KV8102-IM	OCB-LE9003-JNF1	OCB-LE-LL	OCB-LE-LQ
					
7" Video Indoor Touch Screen Built-in Mic and Speaker 10/100 Ethernet DC 12V, PoE Wi-Fi Grey Color	7" Video Indoor Touch Screen Built-in Mic and Speaker 10/100 Ethernet DC 12V, PoE Wi-Fi	Vandal Resistant IP Door Station 1280 x 720@30fps IR up to 15ft, IK9 & IP66 Built-in Mic and Speaker DC12V, PoE LTS NVR Compatible	IP Intercom Camera Module, PoE 21920 x 1080 IR up to 15ft 1800 Wide Angle of View LTS NVR Compatible	IP Intercom 6 Buttons Module	IP Intercom Keypad Module

Module			Accessories		
OCB-LE-M	OCB-LE-HM	OCB-LE-CL	OCB-LE-BDE1 OCB-LE-BDV1	OCB-LE-BDE2 OCB-LE-BDV2	OCB-LE-BDE3 OCB-LE-BDV3
					
IP Intercom Mifare Card Reader Module	IP Intercom Indicator Module	IP Intercom Blank Module	1 Module Mount Frame Flush or Surface Mount	2 Module Mount Frame Flush or Surface Mount	3 Module Mount Frame Flush or Surface Mount

2-4 Door Controller & 1 Door Terminal			
OCB-K2802/OCB-K2804	OCB-K1T501S/OCB-K1T501SF	OCB-L2312EF	OCB-L2312MF
			
<p>2/4 Door Controller Up to 4 Wiegand Readers UL Listed Up to 10,000 Cards and 50,000 Events Logs Build-in 12VDC 6.5A power supply TCP/IP</p>	<p>1 Door Mifare Terminal with 2MP IPC (LTK3500SF with Fingerprint) Support 1 Additional Reader Up to 50,000 Cards, 200,000 Event Logs and 5,000 Fingerprints TCP/IP and Wi-Fi, DC 12V Build-in Mic and Speaker IP65 Weatherproof/ UL Listed</p>	<p>Gen 2 1 Door Card/Code Terminal Support 125KHz Proximity and 13.56MHz Mifare UP to 5,000 User Profile, DC 12V (Card or/and Passcode) IP65 Weatherproof, IK10 Vandel Proof, Metal Housing, Wiegand Output</p>	<p>Gen 2 1 Door Card/Fingerprint Terminal Support Fingerprint and 13.56MHz Mifare UP to 2,000 User Profile (Card or/and Fingerprint) IP65 Weatherproof, Metal Housing IK10 Vandel Proof, DC 12V Wiegand Output</p>

Corporate Values





Personalized Customer Service

To maintain our standard of furnishing our clients with the best in the market we offer individualized, free consultations, to reduce costs so that our client's bills are lower, maintain a secure and mutually beneficial relationship. We continuously train our personnel to quickly identify and provide solutions to our customers' individual needs.

Readers and Cards

OCB-K1802M (K)	OCB-K1107M (K)	OCB-L2212M (K)	OCB-K1103M (K)	OCB-L2215M (K)
				
<p>Slim Mifare Classic Reader Wiegand 26/34 Selectable IP65 Weatherproof LTK1802MK is reader and keypad</p>	<p>Slim Mifare Classic Reader Wiegand 26/34 Selectable IP65 Weatherproof LTK1107MK is reader and keypad</p>	<p>Mifare Classic Reader Wiegand 26/34 Selectable IP64 Weatherproof is reader and keypad</p>	<p>Mifare Classic Reader Wiegand 26/34 Selectable IP64 Weatherproof is reader and keypad</p>	<p>Vandel Proof Mifare Reader Wiegand 26/34 Selectable IP65 Weather and IK10 Vandel Proof LTK1104MK is reader and keypad</p>
OCB-K1F100-D8E	ISO-KET/KEY-CHAIN	HID-1326	HID- H1326C50	OCB-12-4AH OCB-12-7AH / OCB-12-12AH
				
<p>Mifare UL Listed USB Issuer Work with PC NVMS 7000 Software Easy Enrolling Cards at Manager Desktop</p>	<p>Mifare Classic Credentials Card/Fob/Watchband 13.56 Mifare 8 and 10 Digit Card Numbers Printed</p>	<p>HID 125kHz Mini Mullion Reader Works with Controllers via Wiegand, Napco Packaging, HID Product</p>	<p>HID 1326 ProxCard II 50 pieces Clamshell Cards Napco Packaging HID Product</p>	<p>Backup Battery DC12V, 4Ah / 7Ah / 12Ah</p>

Strikes/Maglocks **Cables**

OCB-995NO/NC	AR-600M-UL/ AR-1200-UL	AR-600MD/ AR-1200D	OCB-PS18/6-1000-UL	OCB-PS1822B-CMR
				
Electrical Strike NC/NO Build-in LBM DC 12V Only Cylindrical Latch Only	UL Listed Maglock 600lb / 1200lb Holding Force DC 12V or DC 24V	UL Listed Double Door Maglock 600lb / 1200lb Holding Force DC 12V or DC 24V	18/6 Reader Cable 500ft 18 Gauge, 6 Wire, 500ft Shielded, Stranded ETL and CMR Rated Gray	All-in-One Banana Peel Cable 18/4 for Lock Power 22/2 and 22/4 for Exit Devices Shielded 22/6 for Reader ETL and CMR Rated



Maglock Brackets

AR-600M-LZ	AR-600M-U	AR-LZ1200
		
LZ Bracket For Inward Swinging Door	LZ Dress Bracket For Inward Swinging Door	LZ Bracket For Inward Swinging Door

AR-600M-LZD	AR-600M-UD	AR-600M-U
		
LZ Bracket For Inward Swinging Door	LZ Dress Bracket For Inward Swinging Door	LZ U Bracket For Inward Swinging Door

Exit Buttons

OCB-388	OCB-388L	OCB-700M	OCB-806-S
			
Exit Button SPST(NO Only) 1 Gang	Exit Led Button SPDT(NO /NC) 1 Gang	Exit Button SPDT(NO /NC) 1 Gang	Touchless Exit Aluminum Alloy 3.39" x 1.97" x 1.34"
OCB-806-A	OCB-800A		
			
Touchless Exit 1-25s Timer SPDT (NO/NC)	Exit Button Aluminum Alloy 3.54" x 1.38" x 1.14"		

Accessories



FIB207	FIB555	FIB560	FIB555
			
Fiberfish II 3/16 Inch Dia., 6 Foot Orange Rod Kit	Fiberfish II Kit (30' of rod in carrying case)	LED-Tip fits 3/16' and 5/32' kits	Starter Kit for 3/16 & 5/32 Rods
		Revised Attachment Kit for 3/16 & 5/32 Rods	
GLF407	GLF408	GLF403	GLF718
			
Glowfish II 5/32 Inch Diameter, Plastic Coated 6 Foot ,Glow-in-the-Dark Rod Kit 5/32' , Glow Fish II 6' Kit	Glowfish II 5/32 Inch Diameter, Plastic Coated 3 Foot , Glow-in-the-Dark Rod Kit. 5/32' ,Glow Fish II 3' Kit	5/32' Glow Fish II 6' Bullnose/Bullnose rod (replacement Rods)	-5/32 Inch Diameter Plastic Coated, Glow-in-the-Dark 18 Inch Tool Box , Kit .18" Toolbox' Kit (8) ,5/32' glow rods 3



We Have You Covered Like Nobody Else



airMAX WIRELESS















LOCOM2-US	LOCOM5-US	NBE-M5-16	NBE-M5-19	NSM5
				
2.4 GHz NanoStation LocoM2 8.5 dBi, 150+ Mbps 5+ km	5 GHz NanoStation LocoM5 13 dBi, 150+ Mbps 10+km	5 GHz NanoStation LocoM5 16 dBi, 150+ Mbps 10+km	5 GHz NanoBeam M5 19 dBi, 150+ Mbps 15+km	5 GHz Nanostaion M5 14.6-16.1 dBi 150+Mbps; , 15+ km
AMO-5G10	AMO-5G13	UB-AM	ROCKET-M5	R5AC-LITE
				
5 GHz airMAX Omni Antenna 10 dBi	5 GHz airMAX Omni Antenna 13 dBi	Universal Antenna Mount	5 GHz Rocket M5 BaseStation 150+Mbps	5 GHz Rocket AC BaseStation 500+ Mbps
LBE-5AC-GEN2	NBE-5AC-GEN2	PBE-5AC-GEN2	NS-WM	NBE-WMK
				
5 GHz LiteBeam AC Gen2 23 dBi; 450+ Mbps 10+ km	NanoBeam AC Gen2 19 dBi; 450+ Mbps 15+ km	5 GHz PowerBeam AC Gen2 25 dBi; 450+ Mbps 25+ km	Wall Mount Kit For NanoStation	Wall Mount Kit For NanoBeam









UniFi EdgeMAX







Simple • Enhanced • Connected

UniFi ROUTING/SWITCHING/WIRELESS









US-8	US-8	US-8-150W-US	US-16-150W
			
8 Port Manged Switch (8) Gigabit Ethernet Ports (1) PoE Passthrough Port Power via 48V passive PoE or 48V DC power. 12W	8 Port Manged Switch-4PoE (8) Gigabit Ethernet Ports (4) auto-sensing PoE Ports 15W outpur per PoE port	8 Port Manged PoE Swtich (8) Gigabit PoE Ports (2) Gigabit SFP Ports 150W	16 Port Manged PoE Swtich (16) Gigabit PoE Ports (2) Gigabit SFP Ports 150W
US-16-XG	US-24-250W US-24-500W		US-48-500W US-48-750W
			
16 Port Manged Fiber Swtich (12) 1G/10G SFP+ Ports (4) 1G/10G RJ45 Ports 36W (Excludes SFP/SFP+Modules)	24 Port Manged PoE Swtich (24) Gigabit PoE Ports (2) Gigabit SFP Ports 250W /500W		48 Port Manged PoE Swtich (48) Gigabit PoE Ports (2)1/10 Gbps SFP Ports (2)1 Gbps SFP Ports, 500W /750W
USG	USG-PRO-4-US	UAP-AC-LITE-US	UAP-AC-LR-US
			
Gateway Router (1) RJ45 Serial Port (3) Gigabit Ethernet Ports 7W	Enterprise Gateway Router (1) RJ45 Serial Port (2) 10/100/1000 RJ45 Ports (2) 10/100/1000 RJ45/SFP Combination Ports 40W,2 GB DDR3 RAM, 4 GB Memory	UniFi AP AC LITE 160 x 31.45 mm, 300Mbps@2.4GHz (1) 10/100/1000 Ethernet 867Mbps@5GHz, Up to 400ft r 802.3af/A PoE & 24V PoE Indoo, 250+ Users	UniFi AP,AC Long Range 175.7 x 43.2 mm, Up to 600ft, Indoor (1) 10/100/1000 Ethernet 450Mbps@2.4GHz, 867Mbps@5GHz 802.3af/A PoE & 24V PoE 250+ Users
UAP-AC-PRO-US		UAP-AC-HD-US	UAP-AC-SHD-US
			
UniFi AP, AC PRO 196.7 x 35 mm, (2) 10/100/1000 Ethernet 450Mbps@2.4GHz, 1300Mbps@5GHz 802.3af PoE/802.3at PoE+ Up to 400ft, Indoor/Outdoor, 250+ Users		UniFi AP AC HD 220 x 48.1 mm, (2) 10/100/1000 Ethernet 800Mbps@2.4GHz, 1733Mbps@5GHz 802.3af PoE, Up to 400ft , Indoor/Outdoor 500+ Users	UniFi SHD 220 x 48.1 mm, (2) 10/100/1000 Ethernet 800Mbps@2.4GHz, 1733Mbps@5GHz 802.3at PoE+, Up to 600ft Indoor/Outdoor (Covered), 1000+ Concurrent Clients <i>PoE Switch Not Included</i>

UAP-AC-M-US	UMA-D-US	UAP-AC-M-PRO-US	UAP-AC-IW
			
<p>UniFi AC MESH 139.7 x 86.7 x 25.75 mm (1) 10/100/1000 Ethernet 802.3af/A PoE & 24V PoE Up to 600ft , Indoor/Outdoor 250+ Users</p>	<p>Directional Dual-Band Antenna 201.3 x 128.0 x 32.5 mm 1 x 10/100/1000 Ethernet Port Beamwidth -2.4GHz 90° , 5GHz 45° Indoor/Outdoor <i>Optional mesh antenna designed to work with the UniFi® ACMesh AP</i></p>	<p>UniFi AC MESH PRO 343.2 x 181.2 x 60.2 mm (2) 10/100/1000 Ethernet 802.3af PoE, Built-in antenna Up to 600ft , Outdoor 250+ Users</p>	<p>UniFi AP, AC In-Wall 139.7 x 86.7 x 25.75 mm (3) 10/100/1000 Ethernet (1) Uplink , (2) Switch Ports 300Mbps@2.4GHz, 867Mbps@5GHz 802.3at PoE+ , Indoor 250+ Concurrent Clients <i>PoE Switch Not Included</i></p>
UAP-AC-IW-PRO	UC-CK	UCK-G2	
			
<p>UniFi AP, AC In-Wall 139.7 x 86.7 x 25.75 mm (3) 10/100/1000 Ethernet (1) Uplink , (2) Switch Ports 450Mbps@2.4GHz, 1300Mbps@5GHz 802.3at PoE+ , Indoor 250+ Concurrent Clients <i>PoE Switch Not Included</i></p>	<p>UniFi Cloud Key, Controller 21.7 x 43.4 x 121.9 mm, (1) 10/100/1000 Ethernet Port, 802.3af PoE or Micro-USB 5V, Minimum 1A, Connect up to 1 USG Connect up to 1 USW(UniFi Switch) Connect up to 23 Access Points 1000 Connected Clients <i>PoE Switch Not Included</i></p>	<p>UniFi Cloud Key Gen2 27.10 x 46.80 x 119.75 mm (1) 10/100/1000 Ethernet Port 802.3af PoE or Micro-USB 5V, Minimum 1A Connect up to 1 USG Connect up to 10 USW(UniFi Switch) 2000 Connected Clients <i>PoE Switch Not Included</i></p>	



EdgeMAX ROUTING/SWITCHING

ERLITE-3	ER-X-SFP-US	ER-X-US	ES-5XP
			
<p>EdgeRouter Lite (3) Gigabit routing ports (1) RJ45 Serial Port 7W, 512 MB RAM Size, 2GB Storage Size</p>	<p>EdgeRouter X SFP (5) Gigabit RJ45 ports with passive PoE, (1) Gigabit SFP port 5W, 256MB RAM Size, 256MB Storage Size</p>	<p>EdgeRouter X (5) Gigabit Ethernet ports Power via 24V passive PoE or 12V DC power, 5W 256MB RAM Size, 256MB Storage Size</p>	<p>EdgeSwitch 5 Port Managed PoE, (5) Gigabit Ethernet ports (1) 10/100 Ethernet Management Port 24V Passive PoE; 60W</p>
ES-8-150W	ES-16-150W	ES-24-250W	
			
<p>EdgeSwitch 8 Port Managed PoE (8) Gigabit RJ45 Ports (2) SFP Ports, (1) Serial Console Port Supports POE+ IEEE 802.3at/af and 24V Passive PoE; 150W</p>	<p>EdgeSwitch 16 Port Managed PoE (16) Gigabit RJ45 Ports (2) SFP Ports, (1) Serial Console Port Supports POE+ IEEE 802.3at/af and 24V Passive PoE; 150W</p>	<p>EdgeSwitch 24 Port Managed PoE (24) Gigabit RJ45 Ports, (2) SFP Ports (1) Serial Console Port Supports POE+ IEEE 802.3at/af and 24V Passive PoE; 250W</p>	

433MHz Wireless WIRELESS INTRUSION ALARM





<p>DS-PWA32-KST</p> 	<p>433MHz Wireless Control Panel Kits with keyfob and IC Cards (3G/4G Version). LAN+WIFI+3/4G Including : DS-PWA32-HSR * 1 DS-PD2-P10P-W * 1 DS-PD1-MC-WWS * 1 DS-19K00-Y * 1 DS-PTS-MF * 5e</p>	<p>DS-PWA32-KGT</p> 	<p>433MHz Wireless Control Panel Kits with keyfob and IC Cards.(GPRS Version) . LAN+WIFI+GPRS DS-PWA32-HGR 433MHz, White* 1 DS-PD2-P10P-W 433MHz * 1 DS-PD1-MC-WWS 433MHz * 1 DS-19K00-Y 433MHz * 1 IC Card * 5</p>
<p>DS-PWA32-HS</p> 	<p>32 wireless inputs/8 wireless keyfobs/4 wireless output expanders/2 wireless siren/ LAN+WIFI+GPRS/RF 433MHz. -Two-way wireless communication, no wires, no fuss. -Voice prompts, easy installation and operation. -AES-128 data encryption. -4520mAh backup battery. -2ch on board video verification</p>	<p>DS-PTS-MF</p> 	<p>Wireless Tag. For panel and keypad</p>
<p>DS-19K00-Y</p> 	<p>Wireless Keyfob 433MHz/868MHz Button: Arm/Disarm/Stay Arm/ Panic Alarm/ Alarm Elimination Frequency: 433MHz/868MHz Distance: 300m (Open area)</p>	<p>DS-PD2-D10P-W</p> 	<p>Wireless Dual-Tech Detector Microwave + PIR 433MHz RF two-way wireless. Power by battery AES-128 encryption Pet Immunity 25KG Detection range: 10M*10M, 85 degree Alarm: Tamper alarm, intruder alarm Communication distance: 800M (Open Space)</p>
<p>DS-PD2-P15C-W</p> 	<p>Wireless Dual-Tech Detector Microwave + PIR 433MHz RF two-way wireless Power by battery AES-128 encryption Detection range: 15M*15M, 20 degree Alarm: Tamper alarm, intruder alarm Communication distance: 800M (Open area)</p>	<p>DS-PD1-MC-WWS</p> 	<p>Wireless Magnetic Contact(433MHz) 433MHz RF two-way wireless Power by battery AES-128 encryption Alarm: Tamper alarm, intruder alarm Communication distance: 800M (Open area)</p>
<p>DS-PD1-EB-WR</p> 	<p>Wireless Panic Button (433MHz) 433MHz RF two-way wireless Power by battery AES-128 encryption Alarm: Tamper alarm, panic alarm Communication distance: 800M (Open area)</p>	<p>DS-PMA-WBELL</p> 	<p>Wireless Siren (433MHz) 433MHz RF two-way wireless 350mAh battery AES-128 encryption Tamper alarm Communication distance: 800M (Open area)</p>

INTRUSION ALARM

DS-PD2-P12QE-C	DS-PD2-D10PE	DS-PD1-P10P
		
<p>Detection range: 12M, 360 degree Alarm: Tamper alarm, intruder alarm. Creep Area, Sealed optics, Dul-EOL on board Tamper protection, Bluewave Technology Digital Temperature Compensation Automatic Sensitivity, Ceiling/Wall bracket include, 3 Microwave Frequencies EN-Grade 2</p>	<p>PIR+Microwave Pet Immunity 25KG Detection range: 10M*10M, 85 degree Alarm: Tamper alarm, intruder alarm. Pet immunity, Sealed optics, Dul-EOL on board Tamper protection, Bluewave Technology Digital Temperature Compensation Automatic Sensitivity, 3 LED indicator Ceiling/Wall bracket include 3 Microwave Frequencies , EN-Grade 2</p>	<p>Pet Immunity 10KG Detection range: 10M*10M, 90 degree Alarm: Tamper alarm, intruder alarm</p>

PIR DETECTOR
Photoelectric Smoke detector

VIBRATION DETECTOR

OCB-828	OCB-828-2w	OCB-702	OCB-972	OCB-962
				
<p>Photoelectric chamber, DC12V/DC24V, auto reset, network output, with installation base</p>	<p>Photoelectric chamber, DC12V/DC24V, auto reset, network output, with installation base 2 wire</p>	<p>Sensibility adjustable: high, medium, low Use with OCB-972, strong detection ability, long-frequency vibration and shock</p>	<p>Standard voltage: 12VDC, Standard current: 100-150mA processing method: input pulse count trigger Input sensitivity: analogue, continuously adjustable; System reset method: manual and automatic optional</p>	<p>Glass break</p>

MAGNETIC CONTACTS

OCB-424R	OCB-55H	OCB-61	OCB-57R	OCB-03R	OCB-034R
					
<p>Overhead W/ adjustable Bracket</p>	<p>OVERHEAD Gap40-70mm. NC, Metal housing, Silver</p>	<p>OVERHEAD Gap40-70mm NC, Metal housing, Silver, 50-70m</p>	<p>Wired Roller Door Sensors. NC, Metal housing, Silver, 50-70mm</p>	<p>Recessed Magnetic Contact</p>	<p>Recessed Magnetic Contact</p>

INTRUSION ALARM					
OCB-53	OCB-11RT	OCB-10R	OCB-52	OCB-24ST	OCB-25ST
					
Commercial Surface Mount Magnetic Contact	1" recessed magnetic contact, with screw terminal.	Recessed Stubby Magnetic Contact	Wired Zinc-alloy Gap:30-40mm Size : 50mm*20mm*10mm	Flange Mount Magnetic Contact	Surface Mount Magnetic Contact

INTRUSION ALARM			
OCB-54	OCB-SS072	OCB-76	OCB-103
			
Panic Button Abs Housing in Black	Tamper	PANIC BUTTON NC/NO	Metal pedal switch, white box



Corporate Values

Total Honesty in Our Service

We consider ourselves as the market leaders in supplying our customers with accurate, helpful, and trustworthy information. We strongly believe in developing and maintaining long-term relationships, keeping the client's best interest as the goal of every sale, this way not only does the client highly benefit, but also us..

SIRENS				
OCB-607	OCB-608	OCB-605DT	OCB-900	OCB-S350
				
Electronic siren Operating Voltage: 6-15VDC Rated Voltage:12VDC Rated power:30W SPL DB/1M:118±3 Dual Tones	Electronic siren Operating Voltage: 6-15VDC Rated Voltage:12VDC Rated power:20W SPL DB/1M:112±3 Dual Tones	Piezo Strobe Siren Operating Voltage: 6-15VDC Rated Voltage:12VDC Rated power:15W SPL DB/1M:104±2 Dual Tones	Outdoor siren, PP housing with UV, tamper switch inside, quick wiring terminal inside.	Metal box, 20W siren inside, tamper switch, big strobe light



BEAMS

OCB-2060		OCB-2100	
	<ul style="list-style-type: none"> -Beam: Dual -Optical source: infrared digital pulse -Response speed: 50-700m/s -Alarm output: NO/NC -Contact capacitor: DC 30V/0.5MAmax -Voltage: DC13.8-24V AC11-18V P≥15W 	<ul style="list-style-type: none"> Current: 40MAmax 40MAmax 55MAmax 55MAmax 65MAmax 65MAmax 70MAmax 80MAmax -Operating temperature: -25 ~ 55 -Size: 170mmX83mmX75mm -Anti-tamper switch: NC touching capability:DC24V 0.5MAmax -Optial axis asjurement: H:180° V:20° -Material: PC engineering material 	

OCB-60G	OCB-250L	OCB-2T100
		
<ul style="list-style-type: none"> -The receiver with 7 LED signal indicator without installment base, -Outdoor ≤ 60M,indoor ≤180 	<ul style="list-style-type: none"> -The receiver with 5 LED signal indicator with better lens and plastic base, Outdoor ≤ 250M, indoor ≤750 	<ul style="list-style-type: none"> -Solar-powered wireless beam detector, two beams, outdoor distance≤90M

OCB-0430 (30 mts)	OCB-0460 (60 mts)
	<p>Apply to balcony, windows and gates etc.</p> <p>Product Features</p> <ul style="list-style-type: none"> -Anti-tamper function -Dual MCU for counting, intelligent analyses technology -Easy adjustment -Anti-false alarm caused by sunshine and glare -Compatible with several control panels -Four beams recognize principle; prevent alarm caused by animal less than 25 kg. -Rectangular curtain detecting area



OCB-PHNKL	OCB-PHNKI
	
<p>Silver stainless steel brackets, 50cm 1 pair, L-shaped, 50 pairs/carton</p>	<p>Silver stainless steel brackets, 50cm 1 pair, I-shaped, 50 pairs/carton</p>



ACCESSORIES











US LISTED







Guarding Vision

Emergency Lights

OCB-PSE802F	OCB-PSE802FH	OCB-3E0105P-E	OCB-3E0318P-E	OCB-3E0326P-E
				
Single Port Gigabit Injector 30W·802.3af/at 10/100/1000Mbps No Powered Device Detection	Single Port Gigabit Injector 30W·802.3af/at 10/100/1000Mbps	4 PoE Port Switch with 1 Port Uplink 58W·802.3af/at 10/100Mbps, Up to 820ft	16 PoE Port Switch with 2 Gb Uplink and 2 SFP Ports 230W, 802.3af/at, 10/100Mbps, Up to 820ft	24PoE Port Switch with 2 Gb Uplink and 2 SFP Ports, 370W, 802.3af/at, 10/100Mbps, Up to 820ft

CB-3E0109P-E	POE-SW802EG	OCB-3E0518P-E	OCB-3E0526P-E
			
8 PoE Port Switch with 1 Port Uplink 123W, 802.3af/at 10/100Mbps, Up to 820ft	8 Port Gigabit PoE Switch with 2 Gb Uplink 120W, 802.3af/at 10/100/1000Mbps	16 Port Gigabit PoE Switch with 4 Gb Uplink 300W, 802.3af/at 10/100/1000Mbps	24 Port Gigabit PoE Switch with 4 Gb Uplink 420W, 802.3af/at, 10/100/1000Mbps

Testers

OCB-TK30	OCB - IPC-4300ADH PLUS	OCB-IPC-9800ADH PLUS	OCB-X9-ADH
			
Multi-Function Network Cable Tester Testing RJ45=USOC 4/6/8. 10 Base-T, ELA/TIA • 568A/B, AT&T258A Token Ring, BNC, LED, USB	5 in 1TVI, 4.3 inch IPS touch screen, 960*540 resolution 8MP IP TVI CVI AHD IP / and analog camera test Analog camera test and PTZ control Built in WIFI, create WIFI hotspot HDMI input & output 4K 8MP (AHD+Analog)+ HDMI input DC12V 2A, DC48V PoE power output and HDMI out Rapid ONVIF, auto view video, create testing report RJ45 cable TDR test, cable quality test Chrome browser, TesterPlay:Display camera stream on Tester	5 in 1 TESTER .7 inch Retina touch screen, 1920*1200 Resolution 8MP TVI CVI AHD IP/ Analog camera test Analog camera test and PTZ control Built in WIFI, create WIFI hotspot HDMI input (1080P)& output 4K Rapid ONVIF, auto view video, create testing report RJ45 cable TDR test, cable quality test, Chrome browser, can set cameras parameters DC12V 3A, DC 48V PoE power output TesterPlay:Display camera stream on Tester And mobile devices / PC display simultaneously	5 in 1 tester, 8 inch retina touch screen, 2048*1536 resolution 8MP TVI CVI AHD &IP Analog camera test Analog camera test and PTZ control Built in WIFI, create WIFI hotspot HDMI input (1080P)& output 4K 8MP (AHD+Analog)+ HDMI input Rapid ONVIF, auto view video, create testing report and HDMI out RJ45 cable TDR test, cable quality test. Chrome browser, can set cameras parameters. DC12V 3A, DC 48V PoE power output. Anti-sunlight and screen protecting cover, Backlight buttons, easier to operate in the dark New Cable tracer and video level meter. TesterPlay:Display camera stream on Tester

Power Adapters

OCB-12V1000MA	OCB-12V2000MA	OCB-12V3000MA
		
1000mA, DC 12V	2000mA, DC 12V	3000mA, DC 12V
OCB-24VAC40AC	OCB-24VAC72	PC300
		
1000mA, AC 24V	3000mA, AC 24V	1500mA (Max), AC 24V to DC 12V

Power Supplies

OCB-PS-4DC5EC	OCB-PS-9DC15EC	OCB-PS18DC15EC	OCB-PS18DC30
			
12V DC, 4CH, PTC Fuse 4 Amps Power Box	Power Supply 9ch 12 dc 15 amp regulated, 9 individually fused outputs	Power supply 18ch 12 dc 15 amp regulated, 18 individually fused outputs	Power Supply 18ch, 12DC amp regulated, 18 individually fused outputs
OCB-PS17DC30RM	OCB-PS32DC30RM	OCB-2418-15A	
			
17ch;1ch for DVR/NVR, 16ch for cameras.	1.5U Rack Mount, DC 30A 32CH Input: AC100-240V Output	Input: 110v Output: AC24V 18CH 15A, PTC: 1.1A	

Passive Video Balun Transceivers

OCBP111VL-HD	OCBP111VT-RP-HD	OCBP414VD-HD	OCBP-818CD-HD	OCBPP016-HD
				
1-ch HD passive video balun for: 3/4/5MP HD-TVI, CVI, AHD and CVBS	1-ch HD video & power balun for: 3/4/5MP HD-TVI, CVI, AHD and CVBS	4ch Video Balun Receiver for: 3/4/5MP HD-TVI, CVI AHD and CVBS	8ch Video Balun Receiver for: 3/4/5MP HD-TVI, CVI AHD and CVBS	16ch Video Balun Receiver for: 3/4/5MP HD-TVI, CVI AHD and CVBS

Warning Signs

SIGN 2	SIGN 3	
		
9" (W) x 11"(H)	11" (W) x 18"(H)	

Don't see what you Need ?



www.nodactechnology.com

Go on-line for our complete product offering. and don't forget to look for us in:



Monitor Brackets

MM-LCD-321		OCB-MM3701	
<p>Monitor Bracket For 10"-26" Screen Size Distance To Wall: 35-390mm Max Loading Weight : 10Kg</p>		<p>Monitor Bracket For 17"-37" Screen Size Distance To Wall: 35-380mm Max Loading Weight: 30Kg</p>	
MM-PLB-4-T		MM-LCDW-PLB14	
<p>Monitor Bracket For 26"-55" Screen Size Distance To Wall: 7mm Max Loading Weight : 50Kg</p>		<p>Monitor Bracket For 32"-70" Screen Size Distance To Wall : 70-390mm Max Loading Weight : 75Kg</p>	

Corporate Values

Proactive Communication.

NODAC TECHNOLOG seeks to solve problems before they ever affect our clients, our strong relationship with our suppliers allows us to constantly update the design and functionality of our products, leading to only the best and most efficient of merchandise.



Connectors

OCB-SB-106-B/75	OCB-SB-146/75	OCB-SB-156/75	OCB-SB-144/75
			
<p>BNC Twist-On RG59 Male (20pcs/pack)</p>	<p>BNC Male to RCA Female (20pcs/pack)</p>	<p>BNC Female to RCA Male (20pcs/pack)</p>	<p>BNC Male to RCA Male (20pcs/pack)</p>
OCB-SB-128/75	OCB-SB-186/75	OCB-SB-114-B/75	
			
<p>BNC Coupler Female to Female (20pcs/pack)</p>	<p>BNC Compression for RG59 (20pcs/pack)</p>	<p>BNC Male Crimp-on (20pcs/pack)</p>	

Connectors		
OCB-SB-134/75	RJ45	RJ45-6
		
BNC Male to 2 BNC Female (20pcs/pack)	RJ45 8P8C Cat5e Crimp Connector	RJ45 8P8C Cat6 Crimp Connector
KY5E110	OCB-6/W/ OCB-12/W OCB-16/W/ OCB-6/B OCB-12/B	OCB-HDMI-12 OCB-HDMI-15 OCB-HDMI-25
		
Enhanced Cat5e Keystone Jack	Cable Tie(100 pcs/pack) 6 inch , 8 inch ,12 inch , white/black	HDMI w/Ethernet, 4.5/10/25/50ft Cable Hi-Speed, 1080P/3D,100% Triple Shield 24K, Gold Plated w/Nylon Jacket
OCB-TCS9DC/AC	OCB-HF-100	SAV-9044 / SAV-9041
		
Terminal Connector 9 Terminal, DC & AC Connector/Splitter	100ft HDMI Cable, Hi-Speed 1080P with USB Booster 26AWG	DC Power Connector (20pcs/pack)
SAV-9042T / SAV-9043T		SAV-9042 / SAV-9043
		
DC Power Adapter Cable (20pcs/pack)		Male/Female Pigtail

Control Cable Try Out High Quality OFC Cable

Our CAT5e and CAT 6 cables have Pass FLUKE Permanent Link Test

What is OFC?

OFC stand for Oxygen-Free Copper. Type of copper that electrolytically refined to reduce the level of oxygen to .001% or below.

OCB-PS18/6-500-UL



18 AWG 6 conductor control wire
500 ft stranded
99.99% OFC
CMR Rated
Shielded ETL
Color: Gray

OCB-1822B-CMR



500 ft Stranded control cable
99.99% OFC
18/4 + 22/2 + 22/4 + 22/6
combination cable
shielded 22/6
ETL Rated, CMR Rated
Color: Yellow

Cables (CAT5e, CAT6, Pre-Made Siamese, Coaxial Siamese)

CAT 5e-UL	CAT 6-UL	CAT 5e-CMX CAT 6-CMXT	OCB-1LN6-UE-W
1000ft CAT5e 99.99% OFC UL listed, RoHS Compliant ISO/IEC11801, ANSI/TIA-568B-C.2 Pass Fluke Test, CMR Rated White / Blue / Black	1000ft CAT6 99.99% OFC UL Listed, RoHS Compliant ISO/IEC11801, ANSI/TIA-568B-C.2 Pass Fluke Test CMR Rated, White / Blue /Black	1000ft CAT5e/ CAT6 99.99% OFC ETL Listed, RoHS Compliant ISO/IEC11801, ANSI/TIA-568B-C.2 Pass Fluke Test, Black Outdoor Rated, UV resistance	1000ft CAT6 99.99% OFC UL Listed, RoHS Compliant ISO/IEC11801, TIA-568-C.2 Pass Fluke Test, White/Blue Plenum Rated, CMP

OCB-CAT 5e OCB-CAT 6	OCB-RG-59 / US-500 OCB-RG-59 / US-1000	OCB-RG-59 / US-500-UL/ OCB-RG-59 / US-1000-UL	CCCBL60 CCCBL-100 CCCBL-125
1000ft CCA CAT5e/CAT6 Commercial Grade Network Cable	Siamese Coxial Cable White/ Black Bare Wire 500ft/1000ft RG59 Coaxial 95% Braided +18/2 18 AWG CCA Cable	Siamese Coxial Cable White/ Black Bare Wire 500ft/1000ft RG59 Coaxial 95% Braided + 18/2, Solid 100% 18AWG Oxygen Free Copper	Pre-made HD Siamese Cable with BNC and Power connector 60ft / 100ft / 150ft Color: White / Black

CAT6 Patch Cable, CAT5e Pre-Made Cable

OCB-UTP1	OCB-UTP3	OCB-UTP5	OCB-UTP10	OCB-UTP50 OCB-UTP100
1ft CAT6 Patch Cable 50 Micro Gold Plated 3 Prong Connector, UL Listed RoHS Compliant Pass Fluke Test, CMR Rated Blue/Green/Yellow/Black/White	3ft CAT6 Patch Cable 50 Micro Gold Plated 3 Prong Connector, UL Listed RoHS Compliant Pass Fluke Test, CMR Rated Blue/Black/White	5ft CAT6 Patch Cable 50 Micro Gold Plated 3 Prong Connector, UL Listed RoHSCompliant Pass Fluke Test, CMR Rated Blue/Black/White	10ft CAT6 Patch Cable 50 Micro Gold Plated 3 Prong Connector, UL Listed, RoHS Compliant Pass Fluke Test, CMR Rated Blue/Black/White	Pre-made RJ45 CAT5e Cable LTAC2042-50ft LTAC2041-100ft

Cables (DC Power, VGA, Microphone)

OCB-PS2H	OCB-PS2M	OCB-PS4H	OCB-PS8H
			
DC Power Splitter 1 Female to 2 Male	DC Power Splitter 1 Male to 2 Female	DC Power Splitter 1 Female to 4 Male	DC Power Splitter 1 Female to 8 Male
OCB-M601	OCB-M505	OCB-CM40	OCB-VGA15C OCB-VGA25C OCB-VGA50C
			
High Sensitivity Audio Monitor Mic, Bug range: 30 sq. meters Frequency: 100-5500Hz	high fidelity acoustic noise reduction, Inhibition of environmental noise senior microphone	CCTV Microphone Built-in AGC circuit, pure sound, low noise and high fidelity, Adjustable sensitivity	VGA Extension Cable 10ft VGA Extension Cable 25ft VGA Extension Cable 50ft VGA Extension Cable 100ft

Converters, Splitters, Extenders

RS-001	OCB- HM-VC332	OCB-VGA	OCB-6544	OCB-6548
				
RS-232 to RS-485 Converter A Port Powered RS-232 to RS-485 Converter	USB RJ45 Extender USB2, USB A Female Plug & Play Cable Type: CAT5, 5E, 6, UTP, Extend Distance to 150ft	BNC to VGA Converter Convert BNC Output to VGA Display Monitor Support 1920x1080	1 in/4 out HDMI Splitter Support HDMI 1.3 Support 1080P Support HDCP & 3D	1 in/8 out HDMI Splitter 8 Identical HDMI Outputs Up to 225MHz Support 3D
OCB-POS-340	OCB-V6001P	OCB-8073	OCB-1H33	OCB-1H31
				
POS IP Server	VGA/Audio RJ45 Extender Video Type: VGA Support 1920x1440 1x Stereo Audio (R/L) Extend Distance to 900ft	HDMI Extender Supports 1080P Up to 165ft DC 5V/1A ,power adaptor included	HD-TVI To HDMI Converter Input: 1xHD-TVI Output: 1xHDMI 1xHD-TVI loop out	HD-TVI Distributor Input: 1xHD-TVI Output: 3xHD-TVI

Tools		
AT003	OCB-PBTL-A600A	OCB-PBTL-H510B
		
Coaxial Cable Stripper Cut & Strip Coaxial Cable Durable Delrin Material Rotating Ring	Wire Stripper Strip Wire (12 - 22 gauge) with One Pull of Trigger Built-in Ruler Splicer with Auto Adjust	Professional Crimping Tool BNC Compression, F-Type, RCA Connectors For CATV, DSS sec. and Residential Cable Connection
TE141	OCB-T5009	OCB-806-RG59
		
4 in 1 Wire Cutter & Stripper Easy to Strip & Cut Wire One Lock Control (open/close) AWG 24.22.20.18.16.14.12	Multi-Modular Plug Crimp, Strip and Cut Tool Pro Modular Crimp Tool with Cut and Strip Crimp Types: 8P8C, 6P6C, 4P4C	Coaxial Crimping Tool Hex Tool for BNC F-type Crimp on Connector
OCB-CT019	OCB-TK30	OCB-CT016
		
Enhanced Network cable tester & Scanner	KIT Enhanced Network cable tester 3 & Scanner and tools	Network Multi-Modular Cable Tester
OCB-PBTL-311	OCB-PBTL-A184	OCB-PBTL-H510B
(150mm) Telecom Splices Crimping Tool OCB-PBTL-311" data-bbox="185 770 305 845"/>		
(5.9"/>(150mm) Telecom Splices Crimping Tool Economic Type Crimping	CABLE CUTTERS FOR RG58,59, & 6 Not for steel component	CRIMPING TOOL Adjustment for Crimping different length connectors For use on RG-59(4C)and RG-6(5C)

Accessories		
SCD3818	FLX1418	SCD3818
		
3/8' X 18' Screw Bit -Wire pulling Drill Bit	1/4' X 18' HSS FLEX BIT	1/4' X 24' HSS FLEX BIT
FLX3824	FLX3836	FLX3872
		
3/8' X 24' HSS FLEX BIT	3/8' X 36' HSS FLEX BIT	3/8' X 72' HSS FLEX BIT
QTT3472	FLX3848	FLX1224 FLX1272
		
QUATTRO FLEX BIT 3/4' X 72'	3/8' X 48' HSS FLEX BIT	1/2' X 24' HSS FLEX BIT 1/2' X 72' HSS FLEX BIT
FLX3812	QTT3436	BELLC3812
		
3/8' X 12' BELLHANGER'S BIT	QUATTRO FLEX BIT 1/2' X 18' QUATTRO FLEX BIT 3/4' X 36'	3/8' X 12' CARBIDE BELLHANGER'S BIT

Accessories

BELLC3824	BELLC1224	FLM3854
		
<p>3/8' X 24' CARBIDE BELLHANGER'S BIT</p>	<p>1/2' X 24' CARBIDE BELLHANGER'S BIT 2</p>	<p>3/8' x 54' Carbide Flex Bit</p>

FLM1254	FLX3824	BES-HL452
		
<p>1/2' x 54' Carbide Flex Bit2</p>	<p>WIRE PYTHON - In wall wire fishing system</p>	<p>LED Head Light with adjustable beam</p>

FIB-GUD	WM396	FIB223	FIB-LTT
			
<p>Steering Guide</p>	<p>Wrist Magnet</p>	<p>10' Fish Chain w/ retriever</p>	<p>LEVEL/TEMPLATE TOOL</p>

Corporate Values

Innovation

NODAC TECHNOLOG is an avant-garde corporation with a state-of-the-art distributor control system tailored to best serve our clients' needs. This system enables us to immediately access a database with competitive prices and important information for swift customer service. We aim to find the most beneficial path to equip our clients with the information necessary to efficiently operate our products.



<p>10003C</p> 	<p>106187C</p> 	<p>202003J</p> 	<p>12360C</p> 
<p>EZ-RJ45 Cat5e Connector. 50/Clamshell. The Original EZ-RJ45 CAT5e</p>	<p>RJ45 (8P8C), Cat6 2 pc. Round-Solid 3 Prong, w/Liner. 25/Clamshell.</p>	<p>EEZ-RJ45 Cat5/5e Connector. 100 pc. Jar.</p>	<p>CT-360 External Ground Crimp Tool. Clamshell.</p>
<p>202003J</p> 	<p>12507C</p> 	<p>100021C</p> 	<p>15015C</p> 
<p>EZ-RJ45 Cat6 Connector. 50/Clamshell.</p>	<p>Tele-Titan™ Modular Plug Crimp Tool.</p>	<p>EZ-RJ45 Shielded Cat5e/6, (Internal Ground). 10/Clamshell</p>	<p>Cat 5/6 Cable Jacket Stripper</p>
<p>100062C</p> 	<p>15018C</p> 	<p>100072C</p> 	<p>10514C</p> 
<p>ET he patented EXO Crimp Frame with EZ-RJ45®</p>	<p>All-In-One Stripping Tool, Clamshell.</p>	<p>The patented EZ-RJ45® Die is used with the EXO Crimp Frame™ to terminate EZ-RJ45® connectors.</p>	<p>CCS-6 Cable Cutter, Clamshell.</p>
<p>100072BL</p> 	<p>10517C</p> 	<p>100061C</p> 	<p>10531C</p> 
<p>Replacement blade specifically for the EZ-RJ45®</p>	<p>Electrician's 5" Scissor-Run Scissors, Clamshell.</p>	<p>The patented EXO Crimp Frame® with EXO-EX Die™ was developed to terminate larger cables and conductors</p>	<p>Cutting Pliers, Clamshell. The 5" Side Cutting Pliers</p>

100028C	100024C	1006167C	202044J	13159C
				
ezEX44 Connectors, 50/Clamshell.	ezEX44 Shielded RJ45 Internal Ground Connector, 25/Clamshell. .	Standard CAT5e High Performance RJ45 Connectors.	ezEX44 Connector. 100/Jar.	PRO-Strike Punchdown Tool, w/Combo Blade. Clamshell
100071C	100071C	19105	10711C	TP150
				
The patented EXO-EX Die™	Replacement blade specifically for the EXO-EX Die™	22-in-1 Security Screwdriver Kit. Box	PRO Drywall Saw, Clamshell	Tone and Probe Set. Box
15020C	11008	740C	TPS100C	
				
Double Ended Coax Stripper Clamshell	BNC (8") Removal Tool .	Waterproof RJ45 Splice Coupler. Clamshell.	Pocket PoE Detector, Clamshell.	
TG210K1	TP500C	T130K1		
				
ToneMaster and ToneSeeker Kit, Alligator Clips.	LanSeeker Cable Tester, Clamshell.	VDV MapMaster 3.0 Cable Tester Kit. Box.		



Analog

DWC-B6263WTIR	DWC-B6263WTIR	DWC-V6263WTIR
 <p>Star-Light Universal HD Series, Weatherproof Bullet, AHD,CVI,TVI,960H, 2.1MP CMOS Sensor, P-Iris, 1920x1080 resolution, Dual Voltage, 2.8-12mm Varifocal Auto Iris Lens, True Wide Dynamic Range (100dB), True Day/Night with IR Cut Filter, 100ft Smart IR, Smart 3D-DNR, OSD Control via UTC, IP66. 5 Year Warranty</p>	 <p>Star-Light Universal HD Series, Mini Flat Dome, 1/3" 2.1MP CMOS Sensor, P-Iris, 1920x1080 resolution, 3.6mm Fixed Lens, Digital Wide Dynamic Range (D-WDR), True Day/Night with IR Cut Filter, 50ft Smart IR, Smart 3D-DNR, 12VDC, IP66. 5 Year Warranty</p>	 <p>Star-Light Universal HD Series, Vandal Dome, 100ft Smart IR 2.1MP CMOS Sensor, P-Iris, 1920x1080 resolution, Smart 3D-DNR, AHD,CVI,TVI,960H, 2.8-12mm Varifocal Auto Iris Lens, True Wide Dynamic Range (100dB), True Day/Night with IR, IP66 Cut Filter, OSD Control via UTC, Hydrophobic Dome Coating, Dust and Grease Repels Water, Dual Voltage. 5 Year Warranty. CleanView™ ,</p>
DWC-V4283WTIR	DWC-D3263WTIR	DWC-MC253W-28
 <p>Star-Light AHD Series, Snapit Vandal Dome, Smart 3D-DNR 1/3" 2.1MP CMOS Sensor, P-Iris, 1920x1080 resolution, AHD,CVI,TVI,960H, Dual Voltage, IP68. 2.8-12mm Varifocal Autofocus Lens, True Wide Dynamic Range (100dB), True Day/Night with IR Cut Filter, 100ft Smart IR, 5 Year Warranty. CleanView™</p>	 <p>Star-Light Universal HD Series, Indoor Dome, 2.1MP CMOS Sensor, P-Iris, 1920x1080 resolution, AHD,CVI,TVI,960H, 2.8-12mm Varifocal Auto Iris Lens, True Wide Dynamic Range (100dB), True Day/Night with IR Cut Filter, 100ft Smart IR, Smart 3D-DNR, OSD Control via UTC, Dual Voltage, 5 Year Warranty.</p>	 <p>Star-Light Universal Series, Micro Dome, 1/3" 2.1MP CMOS Sensor, P-Iris, 1920x1080 resolution, AHD,CVI,TVI,960H, 2.8MM Fixed Lens, Wide Dynamic Range (WDR), True Day/Night with IR Cut Filter, Smart 3D-DNR, 12VDC. 5 Year Warranty</p>
DWC-B7753TIR	DWC-V7753WTIR	DWC-PTZ20X
 <p>Star-Light AHD Series, Weatherproof Bullet, 1/3" 2.1MP CMOS Sensor, P-Iris, 1920x1080 resolution, 3.6mm Fixed Lens, Digital Wide Dynamic Range (D-WDR), True Day/Night with IR Cut Filter, 50ft Smart IR, Smart 3D-DNR, 12VDC, IP66. 5 Year Warranty</p>	 <p>Star-Light AHD Series, Mini Flat Dome, 1/3" 2.1MP CMOS Sensor, 50ft Smart IR P-Iris, 1920x1080 resolution, 3.6mm Fixed Lens, Smart 3D-DNR Double Shutter, IP66. Wide Dynamic Range (100dB), True Day/Night with IR Cut Filter, 12VDC, 5 Year Warranty, ,</p>	 <p>Starlight HD Coax 20X PTZ Vandal Dome Camera, 2.1MP. 1080P@30fps, Star-Light 3D-DNR (Digital Noise Reduction), WDR (100dB), 240 Presets, 8 Pattern, 8 Tours, NEMA IP66 Vector Drive [Pan/Tilt at same time.], RS485 Communication, 20x Optical Zoom [4.7mm~94mm], 16x Digital Zoom, Pan 0~360, Automatic Day & Night, Low Power Consumption, Dual Voltage, DNR, 2 Year Warranty.</p>



Analog

DWC-B8553TIR	DWC-B6263WTIR	DWC-B7553WTIR
 <p>Star-Light AHD Series, Snapit Vandal Dome, Smart 3D-DNR, 1/3" 2.1MP CMOS Sensor, P-Iris, 1920x1080 resolution, AHD,CVI,TVI, 960H, 2.8-12mm Varifocal Autofocus Lens, True Wide Dynamic Range (100dB), True Day/Night with IR Cut Filter, 100ft Smart IR, Dual Voltage, IP68. 5 Year Warranty. CleanView™ Hydrophobic Dome Coating Repels Water, Dust and Grease</p>	 <p>Universal HD Series, Weatherproof Bullet, 5MP@20fps 4MP@30fps, HD-Analog, HD-TVI, HD-CVI and all Legacy Resolutions, 2.8-12mm Varifocal Lens with Autofocus, D-WDR, 100ft IR, TDN with IR Cut Filter, 3D-DNR, OSD Control Via Coax, 12VDC, IP66, 5 Year Warranty</p>	 <p>Star-Light Plus Universal HD Series, Weatherproof Bullet, 5MP@20fps/4MP@30fps, HD-Analog, HD-TVI, HD-CVI and all Legacy Resolutions, 4mm Lens, T-WDR, 70ft IR, TDN with IR Cut Filter, Smart 3D-DNR, OSD Control Via Coax, De-Fog, 12VDC, IP66, 5 Year Warranty</p>
DWC-B6563WTIR	DWC-D3563WTIR	DWC-D4583WTIR
 <p>Star-Light Plus Universal HD Series, Weatherproof Bullet, Smart 3D-DNR 5MP@20fps/4MP@30fps, HD-Analog, HD-TVI, 1 Alarm Input, T-WDR HD-CVI and all Legacy Resolutions, OSD Control Via Coax, 100ft IR 2.7-13.5mm Varifocal P-Iris Lens TDN with IR Cut Filter, De-Fog, Dual Voltage, IP66, 5 Year Warranty</p>	 <p>Star-Light Plus Universal HD Series, Indoor Dome, 5MP@20fps/4MP@30fps, HD-Analog, HD-TVI, 1 Alarm Input HD-CVI and all Legacy Resolutions, OSD Control Via Coax 2.7-13.5mm Varifocal P-Iris Lens, T-WDR, 100ft IR, TDN with IR Cut Filter, Smart 3D-DNR, De-Fog, Dual Voltage, IP66, 5 Year Warranty</p>	 <p>Star-Light Plus Universal HD Series, Snapit Indoor Dome, T-WDR, 70ft IR 5MP@20fps/4MP@30fps, HD-Analog, HD-TVI, Smart 3D-DNR HD-CVI and all Legacy Resolutions, OSD Control Via Coax, TDN with IR Cut Filter 2.7-13.5mm Varifocal Motorized Zoom and Auto Focus with P-Iris, 1 Alarm Input, De-Fog, UTP Built in, Dual Voltage, IP66.</p>
DWC-PB753WTW	DW-VAONE41T	DW-VAONE81T
 <p>"First Ever" Star-Light AHD Series 6MP 180 degree Panoramic Bullet, Smart 3D-DNR 1080P, 3x2MP Sensor, 3x4.3mm Fixed Lenses, Wide Dynamic Range (100dB), True Day/Night with IR Cut Filter, UTC(Up the Coax)Programming, De-Fog Compensation, 4th Output for 180 Degree Panoramic View with Zoom Window, HME, AGC, BLC, AWB, Dual Voltage, IP66. 5 Year Warranty.</p>	 <p>VMAX A1 Universal HD 1080P via Coax, Records all HD Formats and All Analog to 960H, H.264, 4ch, 1 terabyte, 120fps@1080P and 120fps@720P, 960H and below, Supports up to 5MP cameras, 1ch Audio in, 1ch audio output, HDMI monitor out, 4 sensor input, 1 relay output, UTC, Spot Monitor Output, Free Pivot CMS Software up to 128 Devices, Free Mobile for iPhone, iPad, Android Smart Phones and Tablets, MAC Compatible, USB Backup, Free DDNS, Watermark Images, Help Menu, Email and Text Event Notification with Snapshot, PTZ Control</p>	 <p>VMAX A1 Universal High Definition 1080P via Coax, Records all HD Formats and All Analog to 960H, H.264, 8ch, 1 terabyte, Free DDNS 240fps@1080P and 240fps@720P, 960H and below, Supports up to 5MP cameras , 1ch Audio in, 1ch audio output, HDMI and VGA monitor out, 4 sensor input, 1 relay output, UTC, Spot Monitor Output, USB Backup Free Pivot CMS Software up to 128 Devices, Free Mobile for iPhone, iPad, Android Smart Phones and Tablets, MAC Compatible, Watermark Images, Help Menu, Email and Text Event Notification with Snapshot, PTZ Control,</p>



Analog

DW-VAONE162T



VMAX A1 Universal High Definition 1080P via Coax, Records all HD Formats and All Analog to 960H, H.264, 16ch, 2 terabyte, 480fps@1080P and 480fps@720P, 960H and below, Supports up to 5MP cameras, 1ch Audio in, 1ch audio output, HDMI and VGA monitor out, 4 sensor input, 1 relay output, UTC, Spot Monitor Output, Free Pivot CMS Software up to 128 Devices, Free Mobile for iPhone, iPad, Android Smart Phones and Tablets, MAC Compatible, USB Backup, Free DDNS, Watermark Images, Help Menu, Email and Text Event Notification with Snapshot, PTZ Control,

DW-VAONE324T



VMAX A1 Universal High Definition 1080P via Coax, Records all HD Formats and All Analog to 960H, H.264, 32ch, 4 terabyte, 480fps@1080P and 480fps@720P, 960H and below, 2 relay output, UTC Supports up to 5MP cameras, 8ch Audio in, 1ch audio output, 4K HDMI and VGA monitor out, 16 sensor input, Spot Monitor Output, Free Pivot CMS Software up to 128 Devices, Free Mobile for iPhone, iPad, Android Smart Phones and Tablets, MAC Compatible, USB Backup, Free DDNS, Watermark Images, Help Menu, Email and Text Event Notification with Snapshot, PTZ Control.

IP

DWC-MB721M4TIR



MEGApix Weather Resistant Bullet, 4.0mm Fixed Lens, 50ft Range IR, OnVIF Compliant, True D&N, 2.1 Megapixels (1920x1080 @ 30fps), 1/2.8" CMOS Sensor, 12x Digital Zoom, PoE + DC12V, WDR (120dB), 3D-DNR, IP66 Certified, No fog or Condensations under any weather condition. 5 Year Warranty

DWC-MB421TIR



MEGApix Weather Resistant Bullet, ONVIF Compliant, 2.1 Megapixels (1080P, 30fps), Triple Codecs (H.264, MJPEG, MPEG4) with Dual Stream, 1/2.8" CMOS Sensor, IP66 Certified 2.8~12mm Auto Focus Lens, 100ft IR, Two-Way Audio 8X Digital Zoom, 4.5X Optical Zoom, True Day and Night, Power over Ethernet [PoE] & DC12V, Local SDHC Card Remote Backup, E-mail Event Notifications, Weatherproof, Web Server Built-in, WDR (120dB), 3D-DNR (3D Digital Noise Reduction), Programmable Privacy Zones (30) & Motion Detection. 5 Year Warranty

DWC-MV72i28V



MEGApix Mini Indoor/Outdoor Vandal Dome, 2.1 Megapixels (1920x1080 @ 30fps), 2.8mm Fixed Lens, 50ft Smart IR, OnVIF Compliant, True D&N, 1/2.8" CMOS Sensor, Dual Codecs(H.264, MJPEG), PoE + DC12V, 3D-DNR, IP66 Certified. 5 Year Warranty

DWC-V6263WTIR



MEGApix Mini Indoor/Outdoor Vandal Dome, 2.1 Megapixel @ 30fps, 4mm Fixed Lens, 50ft Smart IR, True Wide Dynamic Range (120dB), Audio Input and MIC built in, OnVIF Compliant, True D&N, 1/2.7" CMOS Sensor, Dual Codecs(H.264, MJPEG), Micro SD/SDHC/SDXC Class 10 Card Slot for Event and Continuous Recording (card not included), PoE + DC12V, 3D-DNR, IP66, IK10. 5 Year Warranty

DWC-MV421TIRB



MEGApix Indoor/Outdoor Vandal Dome, Black, ONVIF Compliant, 2.1 Megapixels (1080P, 30fps), Triple Codecs (H.264, MJPEG, MPEG4) with Dual Stream, 1/2.8" CMOS Sensor, 2.8-12mm Auto Focus Lens, 8X Digital Zoom, 4.5X Optical Zoom, True Day and Night, 100ft Range IR with Intelligent Camera Sync, Power over Ethernet [PoE] & DC12V, Two-Way Audio, Local SDHC Card Remote Backup, E-mail Event Notifications, IP68 Certified, Junction Box Built-in, Web Server Built-in, WDR (120dB), 3D-DNR Programmable Privacy Zones (30) & Motion Detection. 5 Year Warranty. CleanView™ Hydrophobic Dome Coating Repels Water, Dust and Grease.

DWC-MBT4Wi36



MEGApix Indoor/Outdoor Vandal Dome Camera, 4MP (2560x1440@30fps), 3.6mm Fixed Lens, True D&N, WDR (100dB), 65ft Smart IR, Multiple Codecs (H.265, H.264, MJPEG) with simultaneous Dual Stream, Video Analytics (Line Crossing, Smart DNR Perimeter Intrusion, IP66 Video Tampering, Audio Input, Onvif Compliant, Programmable Privacy Zones, Web Server Built in, PoE+DC12V, 5 Year Warranty



IP

DWC-MB44Wi650



MEGApix Weather Resistant Bullet, ONVIF Compliant, 4 MP (2560x1440, 30fps), 6-50mm Motorized Zoom/Autofocus Varifocal P-Iris, 140ft Smart IR, Lens Dual Codecs (H.264, MJPEG) with Dual Stream, 1/3 CMOS Sensor, 4.2X Optical Zoom, True Day and Night, Power over Ethernet [PoE] & DC12V, Two-Way Audio, Local SDHC Card Remote Backup, E-mail Event Notifications, IP66 Certified, Web Server Built-in, WDR (120dB), 3D-DNR (3D Digital Noise Reduction), Programmable Privacy Zones (4) & Motion Detection. 5 Year Warranty

DWC-MD44WAB



MEGApix Indoor Dome Black, ONVIF Compliant, 4 MP(2560x1440 @ 30fps), Dual Codecs with Dual Stream, 1/3 CMOS Sensor, 2.8~12mm P-Iris Auto Focus Lens, 8X Digital Zoom, 4.2X Optical Zoom, Electronic Day and Night, Power over Ethernet [PoE] & DC12V, Two-Way Audio, Local SDHC Card Remote Backup, E-mail Event Notifications, Web Server Built-in, WDR (120dB), 3D-DNR (3D Digital Noise Reduction), Programmable Privacy Zones (4) & Motion Detection . 5 Year Warranty

DWC-MD44WiAB



MEGApix Indoor Dome Black, ONVIF Compliant, 4 MP (2560x1440 @ 30fps), Dual Codecs with Dual Stream, 1/3 CMOS Sensor, 2.8~12mm P-Iris Auto Focus Lens, 100ft Smart IR, 8X Digital Zoom, 4.2X Optical Zoom, True Day and Night, Power over Ethernet [PoE] & DC12V, Two-Way Audio, Local SDHC Card Remote Backup, E-mail Event Notifications, Web Server Built-in, WDR (120dB), 3D-DNR (3D Digital Noise Reduction), Programmable Privacy Zones (4) & Motion Detection . 5 Year Warranty

DWC-MV74Wi28



MEGApix Mini Indoor/Outdoor Vandal Dome, 4 MP @ 30fps, 2.8mm Fixed Lens, 50ft Smart IR, True Wide Dynamic Range (120dB), OnVIF Compliant, True D&N, 1/2.8" CMOS Sensor, Dual Codecs(H.264, MJPEG), Micro SD/SDHC/SDXC Class 10 Card Slot for Event and Continuous Recording(card not included), PoE + DC12V, 3D-DNR, IP66, IK10. 5 Year Warranty

DWC-MV44WAB



MEGApix Indoor/Outdoor Vandal Dome Black, ONVIF Compliant, 4 MP (2560x1440, 30fps), 2.8-12mm Autofocus Varifocal P-Iris Lens, Dual Codecs (H.264, MJPEG) with Dual Stream, 1/3 CMOS Sensor, 4.2X Optical Zoom, Electronic Day and Night, Power over Ethernet [PoE] & DC12V, Two-Way Audio, Local SDHC Card Remote Backup, E-mail Event Notifications, IP68 Certified, Junction Box Built-in, Web Server Built-in, WDR (120dB), 3D-DNR (3D Digital Noise Reduction), Programmable Privacy Zones (4) & Motion Detection. 5 Year Warranty. CleanView™ Hydrophobic Dome Coating Repels Water, Dust and Grease.

DWC-PZV2M72T



MEGApix 48MP Panoramic 180-Degree Multi Sensor Vandal Dome, 4x12MP CMOS Sensor, Up to 16000x3000 Resolution, 15fps@48MP and 30fps@32MP, 4x7.2mm Auto-Focus Fixed Lens, Dual Codecs (H.264, MJPEG) with simultaneous Dual Stream, True Day/Night with Mechanical IR Cut Filter, Smart DNR, Auto Gain Control (AGC), Back Light Compensation (BLC), Auto White Balance (AWB), Motion Detection, 4 Micro SDXC slots(cards not included), Web Server Built in, Zero Distortion Anti Reflective Glass, VCAM(virtual camera) Multiple Zoom Scenes from One Stream, CleanView™ Hydrophobic Self Cleaning Glass Coating, ONVIF Profile S, IP66, PoE Plus and DC12V, 5 Year Warranty. PoE Injector included.



IP

DWC-PVF9M2TIR



MEGApix Pano 9MP 360-degree Hemispheric Fisheye Indoor/Outdoor Vandal Dome, 360 and 180-degree Panoramic view with Edge to Edge Clarity, 1/1.7 Image Sensor, 30fps @ 3000x3000, 2.1mm fixed lens, Multi Codecs (H.265, H.264, MJPEG) with Simultaneous Dual Streams, 55ft Smart IR, True Day/Night with Mechanical IR Cut Filter, Smart DNR 3D Digital Noise Reduction, Auto Gain Control (AGC), Auto White Balance (AWB), Motion Detection, Micro SD/SDHC Class 10 Card Slot (card not included), Web Server Bullet In, Onvif Profile S, POE and DC12V, 5 Year Warranty.

DWC-MB44iALPR



MEGApix Weatherproof LPR Bullet, 4MP 1/3 Cmos Sensor @ 30fps, 6-50MM Varifocal Motorized Zoom with Autofocus P-Iris Lens, 60ft Smart IR, Dual Codecs (H.264, MJPEG), Smart DNR, AGC, AWB, Programmable Privacy Zones, Two Way Audio, Alarm Input, Relay Output, Web Server Built in, Cold Start -40F(-40C), Micro SD/SDHC/SDXC Class 10 Card Slot (card not included), Onvif Profile S, IP66, PoE and 12VDC, 5 Year Warranty, Captures license plates up to 50mph with up to 60ft capture range.

DW-BJMINI8TR



Blackjack MINI NVR Powered by DW Spectrum IPVMS. Licenses needed, 60 Mbps throughput (equivalent to 12 2.1mp 1080P Cameras at 30fps), RAID 1, Slim Desktop form factor, Linux Ubuntu OS with cross platform support for Windows and MAC client software, Single Gigabit Network Port, Onvif Profile S compliant, Graphic System Health Monitor for hardware performance, Automatic Camera Detection, Fully Customizable Layouts, Easy Drag and Drop Camera Management and Recording, E-Mapping, Advanced Motion Masking and Sensitivity Settings, 4TB usable storage, One-time license charge, fully transferable, with no annual maintenance fees. Keyboard and Mouse Included 5 Year Limited Warranty

DW-BJCUBE4T-DL



Windows based Blackjack Cube NVR Powered by DW Spectrum IPVMS. 4 camera licenses pre-installed expandable to 96 cameras. Capable of managing 96 2.1mp 1080P Cameras at 30fps, 480 Mbps throughput, 4 Mini Display Ports (True HD Adapter Included), Windows® 7 OS on an SSD HDD. Cross platform support for Windows and MAC client software, i7 Processor, 16GB of Memory, Dual Network Card, Onvif Profile S compliant, Graphic System Health Monitor with scheduled auto reboot for hardware performance, True Enterprise Scalability, Automatic Camera Detection, Local Client Display, Fully Customizable Layouts, Easy Drag and Drop Camera Management and Recording, E-Mapping, Advanced Motion Masking and Sensitivity Settings, 4TB HDD, license charge, fully transferable, with no annual maintenance fees. Can Support up to 3 PZV2M72T 48MP Pano) 5 Year Limited Warranty

DW-BJER2U40T



Blackjack E-Rack NVR Powered by DW Spectrum, includes 8 IP Camera Licenses, Windows 10 OS on mirrored SSD's for High Availability, Redundant Power Supply, 2U rack-mount, 12 HDD Bay, 30TB usable RAID storage, Capable of managing 128 1080P Cameras at 30fps, 600 Mbps throughput, RAID 5, i7 Processor, 16G Memory, 1Gbps X2, VGA / HDMI X 2 / DP X 4, Graphic System Health Monitor, True Enterprise Scalability, Automatic Camera Detection, Local Client Display, Fully Customizable Layouts, Easy Drag and Drop Camera Management and Recording, E-Mapping, Advanced Motion Masking and Sensitivity Settings, Keyboard, Mouse and Rail kit are included, 5-Year Limited Warranty.





WARRANTY



Nodac Technology will repair or replace, without charge, any merchandise proved defective in material or workmanship for a period of two year after the date of shipment. All goods requiring warranty repair shall be sent freight prepaid to Nodac Technology Miami Florida. Repairs made necessary by reason of misuse, alteration, normal wear, or accident are not covered under this warranty.

Nodac Technology assumes no risk and shall be subject to no liability for damages or loss resulting from the specific use or application made of the Products. Nodac's liability for any claim, whether based on breach of contract, negligence, infringement of any rights of any party or product liability, relating to the Products shall not exceed the price paid by the Dealer to Nodac Technology for such Products. In no event will Nodac Technology be liable for any special, incidental or consequential damages (including loss of use, loss of profit and claims of third parties) however caused, whether by the negligence of Nodac Technology or otherwise

The above warranty provides the Dealer with specific legal rights. The Dealer may also have additional rights, which are subject to variation from state to state

If a warranty repair is required, the Dealer must contact Nodac at (305) 471-0422 or via e-mail:

rma@nodactechnology.com to obtain a Repair Authorization number (RMA), and provide the following information:

- Model and serial number
- Date of shipment, P.O. number, Sales Order number, or Nodac Technology invoice number
- Details of the defect or problem.

If there is a dispute regarding the warranty of a product which does not fall under the warranty conditions stated above, please include a written explanation with the product when returned. Method of return shipment shall be the same or equal to the method by which the item was received by Nodac Technology.

RETURNS

In order to expedite parts returned to the factory for repair or credit, please call the factory at 305-471-0422 or via e-mail: rma@nodactechnology.com to obtain an authorization number (RMA number if returned for repair, credit or exchange).

All merchandise returned for credit may be subject to a 20% restocking and refurbishing charge.

Goods returned for repair or credit should be clearly identified with the assigned RMA number and freight should be prepaid. Ship to the appropriate address below.

If the goods are to be sent by a FREIGHT FORWARDER, send the goods to:

Service Department
Nodac Technology, Inc.
2236 NW 82 AV
MIAMI, FLORIDA 331122 USA
Tel: 305-471-0422 / Fax:305-591-9422
E-Mail: rma@nodactechnology.com



STORAGE



| CAPTURE | | STORE | | ANALYZE |



SURVEILLANCE

AN UNMATCHED SURVEILLANCE OPTIMIZED PORTFOLIO

Western Digital has edge-to-core storage solutions fine-tuned for the unique demands of surveillance, so you can capture, store and analyze data with technology that adapts to new innovations.

WD Purple™ microSD available in 32GB-256GB
WD Purple™ 3.5-inch available in 1TB-12TB
Ultrastar®, the new GOLD HDD 3.5-inch available in 1TB-14TB



Western Digital, the Western Digital logo, WD, the WD logo, Ultrastar, and WD Purple are registered trademarks or trademarks of Western Digital Corporation or its affiliates in the U.S. and/or other countries.

The microSD mark and logo are trademarks of SD-3C, LLC. All other marks are the property of their respective owners.

Performance will vary depending on your hardware and software components and configurations. Product specifications subject to change without notice.

Pictures shown may vary from actual products.

©2018 Western Digital Corporation or its affiliates. All rights reserved.

GROW YOUR BUSINESS with the OCB Dealer Program

When it comes to security providers, you have options... and choosing the right partner can significantly impact the success of your business. The OCB Dealer Program is specifically designed based on your feedback-to deliver a REAL, MEASURABLE, POSITIVE IMPACT to your bottom line.



Partnership has its Privileges:



Differentiated Products

A high-quality, high-performance, limited distribution product line that enables you to stand out from the competition



Protected Pricing

Competitive pricing, aggressive dealer discounts, and strictly enforced MAP policies to protect your margin opportunities. Discount levels increase as you grow your business.



Dedicated Support

Account managers, system engineers, and technical support specialists provide pre-and-post-sale support, training and job specifications...all dedicated to helping you close more business.

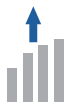

Lead Generation

A comprehensive program, including lead referrals and on-line lead generation-featuring our Special Program to obtain new business and great sales and business opportunities



Partner Advantages

Competitive pricing, aggressive dealer discounts, and strictly enforced MAP policies to protect your margin opportunities. Discount levels increase as you grow your business.



No Hassle Returns



FREE Unlimited Support



iOS/Android Support

- iOS 6 / iPhone 4S, iPad 2, or later
- Android 2.3.3 / CPU@1GHz, Memory@1GB, or above

Miami / USA

2238 NW 82 AV
Miami FL33122
Ph: 1-305-471-0422
Fax: 1-305-591-9422
info@nodactechnology.com

Pompano/ USA

1301 W. Copans Road
Building "A", Suite 3
Pompano Beach, FL 33064
Ph: 954 - 449-4490
Fax: 954 - 933-3914
info@nodactechnology.com

Jamaica

Digital Commodities Ltd.
4 Northend Place,
Kingston 10,
Jamaica
Phone:(876)960-8359
Fax:(876)754-1210
info@nodactechnology.com

Trinidad & Tobago

Circuit Zone LTD Advance
Commercial Building Cor.
Churchill Rosevelt Highway
Boundary Ext. South Aranquez
Phone: 674-8000, 674-9000
Fax: 674-4800
info@nodactechnology.com

Pereira / Colombia

COMPAÑIA DE SEGURIDAD
INTEGRAL CSI. SAS
CRA 19 No 11-162
local 2, Pereira Colombia
Tel: 321-5999
Cel: 320 7276076
info@nodactechnology.com

Venezuela

Seguridad Integral C.A (Seinca)
Ave 8 # F-59 Urb. Irama.
Maracaibo Zulia Venezuela
Phone: +58 261 4182134
Fax +58 261 7482215
Movil +58 414 6260867
USA 001 215 475.9207
info@nodactechnology.com

Costa Rica

ALFAMATIC M.S.C.A.S.A.
ALVIN MORA SANDI
San Jose de Costa Rica,
Embajada USA
850mts norte
Phone: 2296 – 9050.
info@nodactechnology.com

Dominican Republic

PARTNER TECHNOLOGY
CONSULTING, SLR./
NODAC TECHNOLOGY
Av Maximo Gomez esq. Av Bolivar,
Plaza Los Libertadores, Loc. 6 B,
2do Nivel, La Esperilla,
Santo Domingo Tel:1-809-682-3228
info@nodactechnology.com

NODAC/ Europe

NODAC TECHNOLOGY Europe
Calle Pau Claris 162-164
Edificio Financia 6to-6ta.
Barcelona 08037, Espana
europe@nodactechnology.com

NODAC: China/ Asia

China / Asia Room 608
3rd Building Bilinghuating,
Luohu district, Shenzhen, PRC
Tel/Fax: 0086-755-25016796
Fax::86-755-25016706
info@nodactechnology.com

Guatemala

1 ave. 4-23 Zona 9.
Guatemala
Ph: (502) 2360-3469
Fax: (502) 2332-4283
info@nodactechnology.com

Puerto Rico

Antonio Barbosa
Toll Free: 1-866-70-NODAC
ext : 2001
Ph: 305- 471-0422 Ext : 2001
info@nodactechnology.com

Suriname

NV Profession Electronics & Security Systems.
Paramaribo Suriname Livorno weg N° 155.
Phone: 597-485.108 info@nodactechnology.com



*Offering
Technology
developments
that bring security*



SIMPLICITY.
APPLIED



Safety Technology
International



Powering
Trusted Identities